

# Catalyst 4 Footplates - Composite

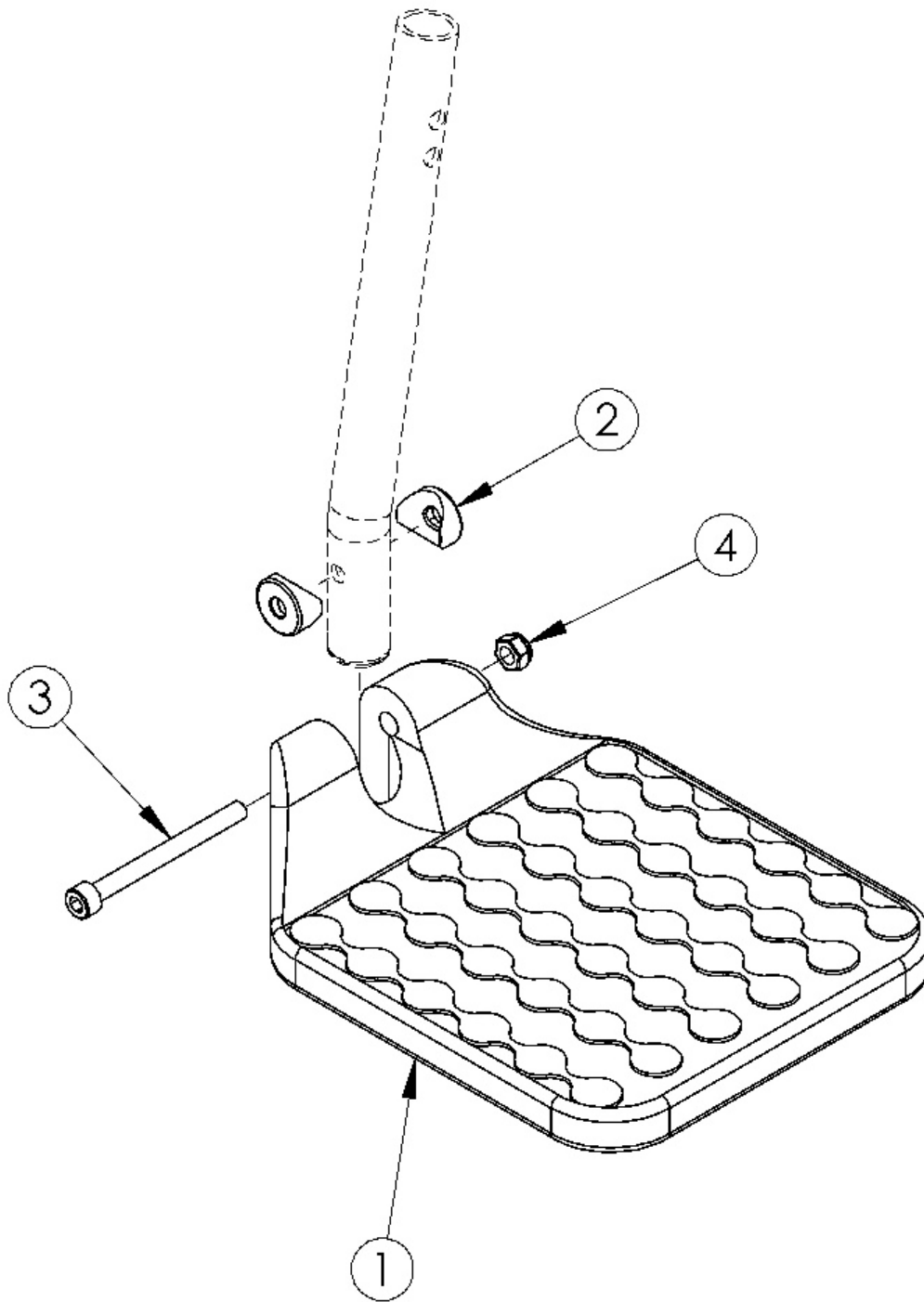

Sizes for footplates are based on seat width. Only compatible with extension tube hangers. If changing footplate style, new extension tubes may be needed.

<b>Item Number</b>	<b>Part Number</b>	<b>Description</b>	<b>Quantity</b>
2-4	112895	Hardware Assembly for Composite Footplate	1
1a	100537	Footplate Composite 14-15" Wide CAT/TILT	1
1b	100540	Footplate Composite 16-17" Wide CAT/TILT	1
1c	100542	Footplate Composite 18-24" Wide CAT/TILT	1
2	000053	Saddle 3/4"	2
3	101849	M6 x 65 SHCS Blk Zn	1
4	100658	M6 Nylock Nut Blk Zn	1