



ORDER FORM

Print pages 1-26 to exclude pictures.

Q700M with SEDEO[®] PRO[™] and JAY[®] Syncra[™] Seating

EIPW25

Customer		Ship To	
Account #		Name	
Date		Address	
PO#		City	
Buyer		State	Zip
Mark For		Phone	

Client Measurements

a) Top of head to seat	in
b) Top of shoulder to seat	in
c) Underarm to seat	in
d) Elbow to seat	in
e) Top of leg to seat	in
f) Shoulder width	in
g) Chest width	in
i) Hip width	in
j) Actual sitting depth	in
m) Foot length	in
n) Knee to foot	in
o) Seat width	in

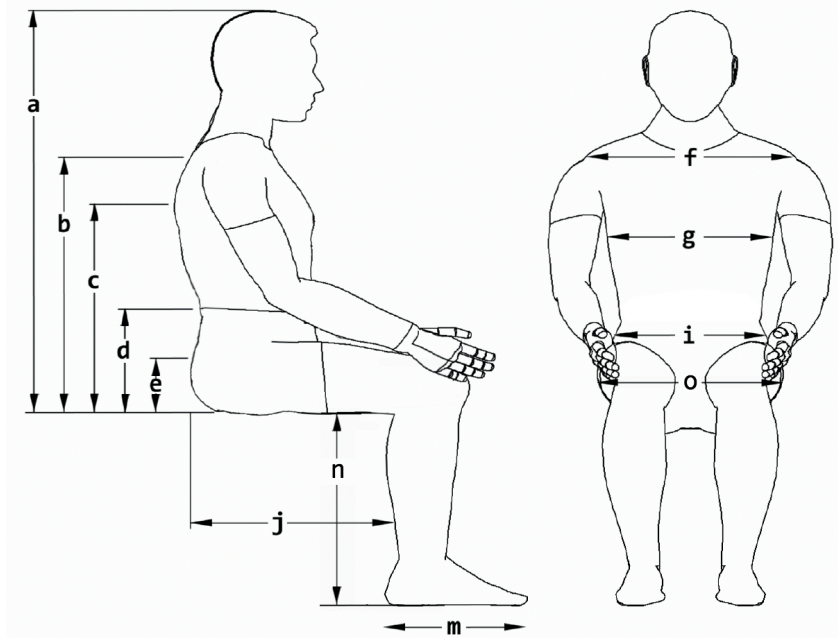

Notes

Chair Specifications

HCPC	K0848 / K0850 / K0856 / K0858 / K0861 K0862 / K0868 / K0877 / K0884
Typical Weight w/out Batteries	330 lbs.
Typical Weight with Batteries	410 lbs.
Power Seating	50° of CG Tilt and Power Recline with 4" mechanical shear reduction / 12" seat elevator
Seat Type	SEDEO® PRO™ / JAY® Syncra™
Seat Size Range	Width 16" to 22" Depth 14" to 22"
Seat-to-Floor Height Range	16.5" to 19"

Mid-Wheel Drive Base Specifications

Drive Wheel Position	Mid-wheel drive
User Weight Capacity	300 lbs. 350 lbs. HD / 450 lbs. HD
Base Size	Width 24.5", Length 36.5"
Minimum Turning Radius	19.8" (excludes footplates)
Drive Control	R-net PM 120A / R-net PM 90A
Driving Range	Up to 18 miles (w/ Group 24 Batteries)
Drive Motors	4-pole 6 mph, 5 mph HD, 8 mph
Drive Wheels	14" w/flat-free inserts (black) 14" w/pneumatic inserts (black)
Casters	6" front / 6" rear (black)
Charger	10A Dual Mode (Compact)
Battery Size	Group 24 / Group 34
Color	8 shroud colors and 7 color accents
Maximum Ground Clearance	3"

BASE			
OPTION	HCPC	DESCRIPTION	RETAIL
Group 3 Standard Duty Mid Wheel Drive Base <i>End Item Number EIPW25 (PRO™ Seat)</i>			\$
250PC197	K0848	Quickie Q700 M NPC No Power Option for SEDEO® PRO™ Seat Included in Base Pricing : Q700 M Base, R-net 90amp Electronics for No Power Seat Functions, SpiderTrac 2.0 Six-Wheel Independent Suspension, 14" Drive Wheels with Dual Density Inserts, 6" Flat Free Casters, ISO Occupied Tie-Down Brackets and 10amp Charger. Max Speed = 6mph, Weight Capacity = 300lbs., STFH = 16.5".	\$8,427.00
250PC198	K0856	Quickie Q700 M SPC Single Power Option for SEDEO® PRO™ Seat Included in Base Pricing : Q700 M Base, R-net 90amp Electronics for No Power Seat Functions, SpiderTrac 2.0 Six-Wheel Independent Suspension, 14" Drive Wheels with Dual Density Inserts, 6" Flat Free Casters, ISO Occupied Tie-Down Brackets and 10amp Charger. Max Speed = 6mph, Weight Capacity = 300lbs., STFH = 16.5".	\$8,427.00
250PC203	K0861	Quickie Q700 M MPC Tilt/Recline for SEDEO® PRO™ Seat Included in Base Pricing: Q700 M Base, R-net 90amp Electronics for No Power Seat Functions, SpiderTrac 2.0 Six-Wheel Independent Suspension, 14" Drive Wheels with Dual Density Inserts, 6" Flat Free Casters, ISO Occupied Tie-Down Brackets and 10amp Charger. Max Speed = 6mph, Weight Capacity = 300lbs., STFH = 16.5".	\$8,427.00
Group 3 Heavy Duty Mid Wheel Drive Base <i>End Item Number EIPW25 (PRO™ Seat)</i>			\$
250PC199	K0850	Quickie Q700 M NPC HD No Power Option for SEDEO® PRO™ Seat Included in Base Pricing : Q700 M Base, R-net 90amp Electronics for No Power Seat Functions, SpiderTrac 2.0 Six-Wheel Independent Suspension, 14" Drive Wheels with Dual Density Inserts, 6" Flat Free Casters, ISO Occupied Tie-Down Brackets and 10amp Charger. Max Speed = 5mph, Weight Capacity = 450lbs., STFH = 16.5".	\$10,843.00
250PC200	K0858	Quickie Q700 M SPC HD Single Power Option for SEDEO® PRO™ Seat Included in Base Pricing : Q700 M Base, R-net 90amp Electronics for No Power Seat Functions, SpiderTrac 2.0 Six-Wheel Independent Suspension, 14" Drive Wheels with Dual Density Inserts, 6" Flat Free Casters, ISO Occupied Tie-Down Brackets and 10amp Charger. Max Speed = 5mph, Weight Capacity = 450lbs., STFH = 16.5".	\$10,843.00
250PC204	K0862	Quickie Q700 M MPC HD Tilt/Recline for SEDEO® PRO™ Seat Included in Base Pricing: Q700 M Base, R-net 90amp Electronics for No Power Seat Functions, SpiderTrac 2.0 Six-Wheel Independent Suspension, 14" Drive Wheels with Dual Density Inserts, 6" Flat Free Casters, ISO Occupied Tie-Down Brackets and 10amp Charger. Max Speed = 5mph, Weight Capacity = 350lbs., STFH = 16.5".	\$10,843.00
Group 4 Standard Duty Mid Wheel Drive Base <i>End Item Number EIPW25 (PRO™ Seat)</i>			\$
250PC201	K0868	Quickie Q700 M NPD No Power Option for SEDEO® PRO™ Seat Included in Base Pricing : Q700 M Base, R-net 120amp Electronics for No Power Seat Functions, SpiderTrac 2.0 Six-Wheel Independent Suspension, 14" Drive Wheels with Dual Density Inserts, 6" Flat Free Casters, ISO Occupied Tie-Down Brackets and 10amp Charger. Max Speed = 8mph, Weight Capacity = 300lbs., STFH = 16.5".	\$13,419.00
250PC202	K0877	Quickie Q700 M SPD Single Power Option for SEDEO® PRO™ Seat Included in Base Pricing : Q700 M Base, R-net 120amp Electronics for No Power Seat Functions, SpiderTrac 2.0 Six-Wheel Independent Suspension, 14" Drive Wheels with Dual Density Inserts, 6" Flat Free Casters, ISO Occupied Tie-Down Brackets and 10amp Charger. Max Speed = 8mph, Weight Capacity = 300lbs., STFH = 16.5".	\$13,419.00
250PC205	K0884	Quickie Q700 M MPD Tilt/Recline for SEDEO® PRO™ Seat Included in Base Pricing: Q700 M Base, R-net 120amp Electronics for No Power Seat Functions, SpiderTrac 2.0 Six-Wheel Independent Suspension, 14" Drive Wheels with Dual Density Inserts, 6" Flat Free Casters, ISO Occupied Tie-Down Brackets and 10amp Charger. Max Speed = 8mph, Weight Capacity = 300lbs., STFH = 16.5".	\$13,419.00

BASE				
OPTION	HCPC	DESCRIPTION		RETAIL
User Weight				\$
250WG23	–	Up to 300 lbs.		NC
250WG15	–	301 to 350 lbs.		NC
250WG25	–	351 to 450 lbs.		NC
Motor Package				\$
250PF98	–	4-pole 8 kph / 5 mph <i>(Standard for Group 3 HD K0850, K0858, K0862)</i>		NC
250PF99	–	4-pole 10 kph / 6 mph <i>(Standard for Group 3 K0848, K0856, K0861)</i>		NC
250PF100	–	4-pole 12.5 kph / 8 mph <i>(Standard for Group 4 K0868, K0877, K0884)</i>		NC
250PF101	–	4-pole 12.5 kph / 8 mph <i>(Upgrade for Group 3 K0848, K0856, K0861)</i>		\$1,235.00
Tracking				\$
250MI01	K0108	SureTrac® Module & Motor Encoders <i>(Improves drive tracking)</i>		\$1,498.00
Drive Wheels  P. 27				\$
250DW58	–	Drive Wheel, 14", Dual Density, Knobby, Black		NC
250DW68	–	Drive Wheel, 14", Pneumatic, V-type, Black		\$268.00
Caster Wheels  P. 27				\$
250CW55	–	Caster Wheels 6", Solid, Black		NC
Wheel Locks				\$
250WL42	–	Wheel Locks		\$113.00
Shroud Color				\$
			Color Accents	
250C119	–	Matte Black	Choose Color	NC
250C165	–	Candy Apple Red	Black	NC
250C166	–	Candy Blue	Black	NC
250C167	–	Candy Purple	Black	NC
250C176	–	Green Apple	Black	NC
250C178	–	Pearl Pink	Black	NC
250C182	–	Silver	Black	NC
250C170	–	American Flag	Black	\$553.00
Color Accents				\$
250EZ20	–	Apple Green		NC
250EZ22	–	Black		NC
250EZ21	–	Blue		NC
250EZ23	–	Orange		NC
250EZ24	–	Red		NC
250EZ25	–	Silver		NC
250EZ19	–	White		NC

BASE					
OPTION	HCPC	DESCRIPTION		RETAIL	
Service Decals				\$	
250D10	–	Army		NC	
250D11	–	Air Force		NC	
250D13	–	Marines		NC	
250D14	–	Navy		NC	
250D15	–	Purple Heart		NC	
ISO Transit Tie Downs				\$	
250T050	–	ISO Transit Package		NC	
LED Lights  P. 27				\$	
250LI04	–	LED Lights and Indicators		\$1,288.00	
250LI11	–	LED Lights and indicators (Available with 4 Power Seat Functions)		NC	
250LI02	–	Omit LED Lights		NC	
Seat Heights				\$	
<i>Note: Available seat-to-floor heights are dependent on 2 options: 1- Battery Size and 2- Powered Seating. Use the matrix below to determine available ranges for your desired options. Measured from front of seat pan to floor with 0° frame angle.</i>					
		Seat Height	Power Seating	No Power Seating	
250HT103	–	16.5"	Group 34	Group 34	NC
250HT55	–	17"	Group 34	GP24 or GP34	NC
250HT104	–	17.5"	Group 34	GP24 or GP34	NC
250HT56	–	18"	GP24 or GP34	GP24 or GP34	NC
250HT105	–	18.5"	GP24 or GP34	GP24 or GP34	NC
250HT57	–	19"	GP24 or GP34	GP24 or GP34	NC
Batteries and Chargers  P. 27				\$	
Group 24 Battery Options (Recommended for max daily range)					
250AG25	E2363	GP24 Flat Top Pair w/Strap MK Gel		\$1,047.00	
250AG26	E2363	GP24 Flat Top Pair w/Strap Brightway AGM		\$789.00	
Group 34 Battery Options (Required for lower seat-to-floor heights)					
250AG27	E2359	GP34 Flat Top Pair w/Straps MK Gel		\$1,009.00	
250AG29	E2359	GP34 Flat Top Pair w/Straps Brightway AGM		\$762.00	
Omit Batteries					
250AG24	–	Battery Harnesses Only (Omit Batteries)		NC	
Chargers					
250BJ28	–	10A Dual Mode (Compact)		NC	

POWERED SEATING

OPTION	HCPC	DESCRIPTION	RETAIL
--------	------	-------------	--------

Power Seating Options  P. 27 \$
Seat Elevator

250PI07	E2300	Seat Elevator, Powered, 300 mm / 12" (Not available with HD or Group 4)	\$3,489.00
250PI08	E2300	C-Me® Seat Elevator, Powered, 300 mm / 12" (Not available with HD or Group 4) C-Me speed up to 3 mph.	\$3,489.00

Seat Tilt

250PA35	E1002	Posterior 50° Tilt	\$7,783.00
250PA36	E1002	Posterior 50° HD Tilt	\$8,857.00

Seat Recline (Available up to 350 lbs.)

250PA37	E1004	150° Powered Recline w/ 4" Shear Reduction	\$7,783.00
250PA39	E1004	150° HD Powered Recline w/ 4" Shear Reduction	\$8,857.00

Seat Tilt/Recline (Available up to 350 lbs.)

250PA41	E1007	Posterior 50° Tilt and 150° Recline Powered, w/ 4" Shear Reduction	\$12,614.00
250PA43	E1007	Posterior 50° HD Tilt and 150° HD Recline Powered, w/ 4" Shear Reduction	\$13,688.00

Power Recline Backrest Preset Home Angle

250QK1	–	90°	NC
250QK2	–	95° (Default Position)	NC
250QK3	–	100°	NC

Pre Set Seat Frame Angle (No Power Seating Options, Increases Seat to Floor Height) \$

250FA10	–	0° (Adds 0" to STFH)	NC
250FA3	–	3° (Adds 1" to STFH)	NC
250FA4	–	6° (Adds 2" to STFH)	NC
250FA5	–	9° (Adds 3" to STFH)	NC

Backrest Frame Type \$

250BF10	–	Tool Angle Adjustable Back, 90°-120°	NC
250BF11	E1225	User Adjustable Manual Semi-Recline Back, 90°-130°, Right (Adjustment lever mounted on opposite side of joystick)	\$628.00
250BF12	E1225	User Adjustable Manual Semi-Recline Back, 90°-130°, Left (Adjustment lever mounted on opposite side of joystick)	\$628.00

Backrest Frame Option \$

250BF13	–	Flip Down, Quick Release	\$135.00
---------	---	--------------------------	----------

Back Cushion Type \$

250BT134	–	SEDEO® Back Cushion (Choose Seating in Section A)	NC
250BT138	–	JAY® Syncra™ (Choose Seating in Section B)	NC
250BT135	–	JAY® J3® (Choose Seating in Section C)	NC
250BT136	–	JAY® J3® Interface Only (Allows JAY Your Way modifications)	NC
250BT137	–	SEDEO® PRO™ Aftermarket Back Adapter (Height adjustable round tubes for traditional mounting)	\$483.00
250BT133	–	OMIT (For personalized mounting. No headrest mount)	NC

POWERED SEATING

OPTION	HCPC	DESCRIPTION	RETAIL
--------	------	-------------	--------

A - SEDEO® Backrest Dimensions

\$

Back Width

250BN28	–	400mm / 16"	NC
250BN29	–	460mm / 18"	NC
250BN30	–	500mm / 20"	NC
250BN31	–	560mm / 22"	NC

Back Shell Height

			Tool Angle Adjust.	150° Recline	Installed Back Height	
250B255	–	460mm / 18"	22°-23°	23°-25°		NC
250B256	–	560mm / 22"	24°-27°	26°-29°		NC
250B257	–	660mm / 26"	28°-30°	30°		NC

Installed Back Height - (From Pan to Top of Back)

250JR32	–	22"	NC
250JR33	–	23"	NC
250JR34	–	24"	NC
250JR35	–	25"	NC
250JR36	–	26"	NC
250JR37	–	27"	NC
250JR38	–	28"	NC
250JR39	–	29"	NC
250JR40	–	30"	NC

Lateral Thoracic Support Pads

250KD31	E0956	Lateral, Swing-Away, Adjustable, Long Pad 150 x 130 mm / 6" x 5" , Right	\$140.00
250KD32	E0956	Lateral, Swing-Away, Adjustable, Long Pad 150 x 130 mm / 6" x 5" , Left	\$140.00
250KD33	E0956	Lateral, Swing-Away, Adjustable, Short Pad 90 x 120 mm / 3.5" x 4.5" , Right	\$140.00
250KD34	E0956	Lateral, Swing-Away, Adjustable, Short Pad 90 x 120 mm / 3.5" x 4.5" , Left	\$140.00

Lateral Thoracic Swing-Away Hardware

250KE45	E1028	Lateral Swing-Away Hardware, Right	\$247.00
250KE46	E1028	Lateral Swing-Away Hardware, Left	\$247.00

POWERED SEATING

OPTION	HCPC	DESCRIPTION	RETAIL
--------	------	-------------	--------

B - JAY® Syncra™ Seating**B - JAY® Syncra™ Back**  P. 26 \$

250JP14	E2620	JAY® Syncra™ Back 16-20" Wide with 3" Contour Depth	\$1,047.00
250JP15	E2621	JAY® Syncra™ Back 22" Wide with 3" Contour Depth	\$1,155.00

B - JAY® Syncra™ Back Width \$

Back can be ordered a different width than seat pan. Armrest will be adjusted to back width ordered.

250JQ07	–	16" Wide (Adjustment range 16 to 17" Wide)*	NC
250JQ08	–	18" Wide (Adjustment range 18 to 19" Wide)*	NC
250JQ09	–	20" Wide (Adjustment range 20 to 21" Wide)*	NC
250JQ10	–	22" Wide (Adjustment range 22 to 23" Wide)	NC

**Additional +1" of shell width adjustment is achievable. Requires purchase of 1" larger foam and upholstery separately.*

B - JAY® Syncra™ Back Shell Options and Height Ranges \$

JAY® Syncra™ Back shells are mounted with a minimim 5.5" gap between the bottom of the shell to the seat pan to accommodate the mechanical shear. Back height can be adjusted in the field with-in the ranges shown based on the back frame type.

JAY® Syncra™ Shell Height

250JR42	–	16" Tall Shell (22" to 24" Back Height)	NC
250JR43	–	18" Tall Shell (24" to 26" Back Height)	NC
250JR44	–	20" Tall Shell (26" to 28" Back Height)	NC
250JR45	–	22" Tall Shell (28" to 30" Back Height)	NC

JAY® Syncra™ Back Installed Back Height (From Pan to Top of Back)

250JR50	–	22" (16" Shell Height)	NC
250JR51	–	23" (16" Shell Height)	NC
250JR52	–	24" (16" Shell Height)	NC
250JR53	–	24" (18" Shell Height)	NC
250JR54	–	25" (18" Shell Height)	NC
250JR55	–	26" (18" Shell Height)	NC
250JR56	–	26" (20" Shell Height)	NC
250JR57	–	27" (20" Shell Height)	NC
250JR58	–	28" (20" Shell Height)	NC
250JR67	–	28" (22" Shell Height)	NC
250JR68	–	29" (22" Shell Height)	NC
250JR69	–	30" (22" Shell Height)	NC

B - JAY® Syncra™ Back Upholstery \$

250BU96	–	Syncra™ Premium Leatherette	NC
250BU97	–	Syncra™ Stretch	NC
250BU98	–	Syncra™ 3DX Microclimatic	NC

POWERED SEATING

OPTION	HCPC	DESCRIPTION	RETAIL
--------	------	-------------	--------

B - JAY® Lateral Thoracic Swing-Away Supports (Requires Pad, Upholstery and Mount)

\$

JAY® Lateral Thoracic Support Pads

250JW35	E0956	Lateral Thoracic (L x H) 100 mm x 127 mm / 4" x 5" Pad - Right	\$135.00
250JW38	E0956	Lateral Thoracic (L x H) 100 mm x 127 mm / 4" x 5" Pad - Left	\$135.00
250JW36	E0956	Lateral Thoracic (L x H) 100 mm x 152 mm / 4" x 6" Pad - Right	\$135.00
250JW39	E0956	Lateral Thoracic (L x H) 100 mm x 52 mm / 4" x 6" Pad - Left	\$135.00
250JW37	E0956	Lateral Thoracic (L x H) 152 mm x 100 mm / 6" x 4" Pad - Right	\$135.00
250JW40	E0956	Lateral Thoracic (L x H) 152 mm x 100 mm / 6" x 4" Pad - Left	\$135.00

JAY® Lateral Thoracic Support Pad Upholstery

250NU01	–	Syncra™ Premium Leatherette	NC
250NU02	–	Syncra™ Stretch	NC
250NU03	–	Syncra™ 3DX Microclimatic	NC

JAY® Lateral Thoracic Swing-Away Mount

250JW41	E1028	Lateral Thoracic Swing Away Bracket - Right	\$268.00
250JW42	E1028	Lateral Thoracic Swing Away Bracket - Left	\$268.00

B - JAY® Syncra™ Fixed Lateral Support Accessory

\$

JAY® Fixed Lateral Support Accessory Hardware (JAY® Fixed Lateral Support is height adjustable)

250JW33	E0956	Fixed Lateral Support Accessory (L x H) 90 mm x 140 mm / 3.5" x 8" - Right	\$135.00
250JW34	E0956	Fixed Lateral Support Accessory (L x H) 90 mm x 140 mm / 3.5" x 8" - Left	\$135.00

POWERED SEATING

OPTION	HCPC	DESCRIPTION	RETAIL
--------	------	-------------	--------

C - JAY® J3® Back

C - JAY® J3® Back - Contour  P. 27 \$

250JP01	E2613	J3® PA Back for 16"-20" Wide	\$575.00
250JP02	E2614	J3® PA Back for 22" Wide	\$854.00
250JP11	E2615	J3® PL Back for 16"-20" Wide	\$671.00
250JP13	E2620	J3® PD Back for 16"-20" Wide (18" and 21" shell height only)	\$805.00

C - JAY® J3® Back Width \$

Back can be ordered a different width than seat pan. Armrest will be adjusted to back width ordered.

250JQ02	–	16"	NC
250JQ03	–	18"	NC
250JQ04	–	20"	NC
250JQ05	–	22"	NC

C - JAY® J3® Back Shell Options and Height Ranges \$

JAY® J3® shells are mounted with a minimim 4" gap between the bottom of the shell to the seat pan to accommodate the mechanical shear. Back height can be adjusted in the field within the ranges shown, based on the back frame type and the amount of usable hardware adjustability.

JAY® J3® Shell Height

			Tool Angle Adjust.	150° Recline	Installed Back Height	
250JR41	–	15" tall shell (Upper Thoracic Med) for 22" Wide	22"-23"	22"-23"		NC
250JR14	–	16.5" tall shell (Upper Thoracic Short)	21"-23"	22"-24"		NC
250JR15	–	18" tall shell (Upper Thoracic Med)	22"-24"	23"-25"		NC
250JR16	–	19.5" tall shell (Upper Thoracic Tall)	24"-26"	24"-26"		NC
250JR18	–	18" tall shell (Shoulder Height) for 22" wide	24"	24"		NC
250JR17	–	21" tall shell (Shoulder Height)	24"-26"	25"-28"		NC
250JR27	–	22.5" tall shell (Shoulder Height)	26"-28"	27"-30"		NC
250JR28	–	24" tall shell (Shoulder Height)	27"-29"	28"-30"		NC

JAY® J3® Installed Back Height (From Pan to Top of Back)

250JR29	–	21"	NC
250JR19	–	22"	NC
250JR20	–	23"	NC
250JR21	–	24"	NC
250JR22	–	25"	NC
250JR23	–	26"	NC
250JR24	–	27"	NC
250JR25	–	28"	NC
250JR30	–	29"	NC
250JR31	–	30"	NC

POWERED SEATING

OPTION	HCPC	DESCRIPTION	RETAIL
C - JAY® J3® Back Spine-Align Fit Kit 2  P. 27			\$
250JS02	K0108	410 mm / 16"	\$149.00
250JS03	K0108	460 mm / 18"	\$149.00
250JS04	K0108	510 mm / 20"	\$149.00

C - JAY® Anterior Thoracic Support  P. 27 \$*Classic-Structure Pull Down Harness (4 point strap, only available with JAY® backrest)*

250K10	E0960	Medium (ATS8302)	\$163.00
250K11	E0960	Large (ATS8303)	\$163.00
250K12	E0960	Extra Large (ATS8304)	\$163.00

C - JAY® J3® Lateral Thoracic Swing-Away Supports \$**Lateral Thoracic Support Pads**

250JW19	E0956	Lateral Thoracic (LxH) 100 mm x 100 mm / 4" x 4" Pad - Right	\$135.00
250JW25	E0956	Lateral Thoracic (LxH) 100 mm x 100 mm / 4" x 4" Pad - Left	\$135.00
250JW20	E0956	Lateral Thoracic (LxH) 100 mm x 127 mm / 4"x 5" Pad - Right	\$135.00
250JW26	E0956	Lateral Thoracic (LxH) 100 mm x 127 mm / 4"x 5" Pad - Left	\$135.00
250JW21	E0956	Lateral Thoracic (LxH) 100 mm x 152 mm / 4" x 6" Pad - Right	\$135.00
250JW27	E0956	Lateral Thoracic (LxH) 100 mm x 152 mm / 4" x 6" Pad - Left	\$135.00
250JW22	E0956	Lateral Thoracic (LxH) 152 mm x 100 mm / 6" x 4" Pad - Right	\$135.00
250JW28	E0956	Lateral Thoracic (LxH) 152 mm x 100 mm / 6" x 4" Pad - Left	\$135.00
250JW23	E0956	Lateral Thoracic (LxH) 152 mm x 127 mm / 6" x 5" Pad - Right	\$135.00
250JW29	E0956	Lateral Thoracic (LxH) 152 mm x 127 mm / 6" x 5" Pad - Left	\$135.00
250JW24	E0956	Lateral Thoracic (LxH) 152 mm x 152 mm / 6" x 6" Pad - Right	\$135.00
250JW30	E0956	Lateral Thoracic (LxH) 152 mm x 152 mm / 6" x 6" Pad - Left	\$135.00

Lateral Thoracic Swing-Away Hardware

250JW31	E1028	Lateral Thoracic Swing-Away Bracket - Right	\$282.00
250JW32	E1028	Lateral Thoracic Swing-Away Bracket - Left	\$282.00

Headrests (Requires Pad, Upholstery, & Mount)  P. 29 \$**Headrest Pad**

250HE36	E0955	SEDEO® Pad Small With Cover (LxH) 240 x 150 mm / 10" x 6" <i>Can only be used with Multi Position Headrest Mount with Quick Release and SEDEO® Upholstery</i>	\$173.00
250HE37	E0955	SEDEO® Pad Flexible, (LxH) 400 x 110 mm / 16" x 4.5" <i>Can only be used with Multi Position Headrest Mount with Quick Release and SEDEO® Upholstery</i>	\$279.00
250HE38	E0955	Whitmyer® Plush Headrest Pad 203 mm / 8"	\$220.00
250HE39	E0955	Whitmyer® Plush Headrest Pad 254 mm / 10"	\$220.00
250HE44	E0955	Whitmyer® Plush Headrest Pad 356 mm / 14"	\$230.00
250HE45	E0955	Whitmyer® Adjust-A-Plush Headrest Pad Small (Narrow) (Adjustable from 6 to 14" Wide x 3" Tall)	\$338.00
250HE46	E0955	Whitmyer® Adjust-A-Plush Headrest Pad Medium (Adjustable from 7 to 16" Wide x 4" Tall)	\$338.00
250HE47	E0955	Whitmyer® Adjust-A-Plush Headrest Pad Large (Standard) (Adjustable from 8 to 18" Wide x 5" Tall)	\$338.00
250HE48	–	OMIT Headrest Pad	NC

POWERED SEATING

OPTION	HCPC	DESCRIPTION	RETAIL
Headrest Pad Upholstery			
250NU10	–	SEDEO® Upholstery	NC
250NU04	–	Syncra™ Premium Leatherette	NC
250NU05	–	Syncra™ Stretch	NC
250NU06	–	Syncra™ 3DX Microclimatic	NC
250NU11	–	Whitmyer® Lycra	NC
Headrest Mount			
250MH32	E1028	SEDEO® Multi-Position Headrest Mount with Quick Release <i>(Only available with SEDEO® Pad)</i>	\$215.00
250MH33	E1028	Whitmyer® Linx Headrest Mount with Quick Release	\$177.00
250MH34	E1028	Whitmyer® Linx-2 Headrest Mount with Quick Release	\$215.00
250MH35	E1028	Whitmyer® AXYS Headrest Mount with Quick Release	\$113.00
250MH36	E1028	Whitmyer® AXYS Offset Headrest Mount with Quick Release	\$135.00
250MH37	E1028	Whitmyer® Cobra FB Headrest Mount with Quick Release	\$322.00
250MH17	–	OMIT Headrest Mount	NC
Push Handles			\$
250PH27	–	Height Adjustable Push Handles	\$322.00
Seat Frame Rails			\$
250SN14	–	Seat Rail Short <i>(For effective seat depth 14" to 18")</i>	NC
250SN15	–	Seat Rail Long <i>(For effective seat depth 17" to 22")</i>	NC
Seat Cushion Type			\$
250ST79	–	SEDEO® (See Section D)	NC
250ST81	–	JAY® Syncra™ Cushion (See Section E)	NC
250ST80	–	JAY® (See Section F)	NC
250ST75	–	Omit	NC
C - Seat Size			\$
Seat Pan Width <i>(Odd sizes not available on SEDEO® cushions)</i>			
250R53	–	16"	NC
250R54	–	17"	NC
250R55	–	18"	NC
250R56	–	19"	NC
250R57	–	20"	NC
250R58	–	21" <i>(Not available with JAY® Syncra™ Cushions)</i>	NC
250R59	–	22"	NC

POWERED SEATING

OPTION	HCPC	DESCRIPTION	RETAIL
Seat Pan Depth (Front of seat pan to front of back cushion – effective depth)			
250RF52	–	14"	NC
250RF53	–	15"	NC
250RF51	–	16"	NC
250RF45	–	17"	NC
250RF46	–	18"	NC
250RF47	–	19"	NC
250RF48	–	20"	NC
250RF49	–	21" <i>(Not available with JAY® Syncra™ Cushions)</i>	NC
250RF50	–	22"	NC

D - SEDEO® Cushions  P. 27 **\$**

250CU82	E2607	SEDEO® Cushion (Sizes 16", 18", & 20" Wide) (Not available with 14" Depth)	\$424.00
250CU83	E2608	SEDEO® Cushion (Size 22" Wide)	\$532.00

E - JAY® Syncra™ Cushion  P. 26 (JAY Your Way modifications available through Customer Service (800) 333-4000) **\$**

250CU87	E2607	JAY® Syncra™ Cushion with Visco Foam (16" to 20" wide)	\$445.00
250CU88	E2608	JAY® Syncra™ Cushion with Visco Foam (22" wide)	\$526.00
250CU89	E2622	JAY® Syncra™ Cushion featuring JAY Flow® Fluid with Cryo™ Technology (16" to 20" wide)	\$580.00
250CU90	E2623	JAY® Syncra™ Cushion featuring JAY Flow® Fluid with Cryo™ Technology (22" wide)	\$671.00
250CU91	E2622	JAY® Syncra™ Cushion with Air Insert - Single Valve (16" to 20" wide)	\$532.00
250CU92	E2623	JAY® Syncra™ Cushion with Air Insert - Single Valve (22" wide)	\$623.00
250CU93	E2622	JAY® Syncra™ Cushion with Air Insert - Dual Valve (16" to 20" wide)	\$537.00
250CU94	E2623	JAY® Syncra™ Cushion with Air Insert - Dual Valve (22" wide)	\$628.00

JAY® Syncra™ Cushion Cover Upholstery

250YR73	–	Syncra™ Premium Leatherette	NC
250YR74	–	Syncra™ Stretch	NC
250YR75	–	Syncra™ 3DX Microclimatic	NC

POWERED SEATING			
OPTION	HCPC	DESCRIPTION	RETAIL
F - JAY® Seat Cushion  P. 28			\$
250CU55	E2622	JAY® X2® Cushion <i>(Sizes 16" - 20" Wide)</i>	\$457.00
250CU56	E2622	JAY® J2® Cushion <i>(Sizes 16" - 20" Wide)</i>	\$467.00
250CU57	E2622	JAY® J2® Deep Contour Cushion <i>(Sizes 16" - 20" Wide)</i>	\$483.00
250CU58	E2623	JAY® J2® Deep Contour Cushion <i>(Size 22" Wide)</i>	\$596.00
250CU59	E2607	JAY® Ion® <i>(Sizes 16" - 21" Wide)</i>	\$424.00
250CU60	E2608	JAY® Ion® <i>(Size 22" Wide)</i>	\$532.00
250CU61	E2607	JAY® Union® <i>(Sizes 16" - 21" Wide)</i>	\$478.00
250CU62	E2608	JAY® Union® <i>(Size 22" Wide)</i>	\$585.00
250CU63	E2607	JAY® Union® Reduced Profile <i>(Sizes 16" - 20" Wide)</i>	\$478.00
250CU64	E2622	JAY® Fusion® <i>(Sizes 16" - 21" Wide)</i>	\$473.00
250CU65	E2623	JAY® Fusion® <i>(Size 22" Wide)</i>	\$564.00
250CU66	E2622	JAY® Fusion® Air Insert Single Valve <i>(Sizes 16" - 21" Wide)</i>	\$532.00
250CU67	E2623	JAY® Fusion® Air Insert Single Valve <i>(Size 22" Wide)</i>	\$623.00
250CU68	E2622	JAY® Fusion® Air Insert Dual Valve <i>(Sizes 16" - 21" Wide)</i>	\$537.00
250CU69	E2623	JAY® Fusion® Air Insert Dual Valve <i>(Size 22" Wide)</i>	\$628.00
250CU70	E2622	JAY® Fusion® Reduced Profile <i>(Sizes 16" - 21" Wide)</i>	\$473.00
250CU71	E2623	JAY® Fusion® Reduced Profile <i>(Size 22" Wide)</i>	\$564.00
250CU72	E2622	JAY® Fusion® Reduced Profile Air Insert Single Valve <i>(Sizes 16" - 21" Wide)</i>	\$532.00
250CU73	E2623	JAY® Fusion® Reduced Profile Air Insert Single Valve <i>(Size 22" Wide)</i>	\$623.00
250CU74	E2622	JAY® Fusion® Reduced Profile Air Insert Dual Valve <i>(Sizes 16" - 21" Wide)</i>	\$537.00
250CU75	E2623	JAY® Fusion® Reduced Profile Air Insert Dual Valve <i>(Size 22" Wide)</i>	\$628.00
250CU76	E2624	JAY® Fusion® Positioning <i>(Sizes 16" - 21" Wide)</i>	\$494.00
250CU77	E2625	JAY® Fusion® Positioning <i>(Size 22" Wide)</i>	\$585.00
250CU78	E2624	JAY® Fusion® Positioning Air Insert Single Valve <i>(Sizes 16" - 21" Wide)</i>	\$553.00
250CU79	E2625	JAY® Fusion® Positioning Air Insert Single Valve <i>(Size 22" Wide)</i>	\$644.00
250CU80	E2624	JAY® Fusion® Positioning Air Insert Dual Valve <i>(Sizes 16" - 21" Wide)</i>	\$558.00
250CU81	E2625	JAY® Fusion® Positioning Air Insert Dual Valve <i>(Size 22" Wide)</i>	\$649.00

F - JAY® Solid Seat			\$
250CU84	–	JAY® Solid Seat	\$92.00

F - JAY® Bundling			\$
<i>Note: To order any JAY® cushion not listed above please see the JAY® price list.</i>			
250JC20	–	JAY® Bundled Cushion	See Price List
		Cushion name or part number	Width Depth

POSITIONING SUPPORTS & ACCESSORIES

OPTION	HCPC	DESCRIPTION	RETAIL
Knee and Thigh Swing-Away Support Pads			\$
Lateral Knee Support Pads and Hardware (must pick pad and mount)			
250XY05	E0953	Lateral Knee Support Pad, Right (4" round)	\$188.00
250XY06	E0953	Lateral Knee Support Pad, Left (4" round)	\$188.00
250XX08	E1028	Lateral Swing-Away Bracket Knee - Right	\$247.00
250XX09	E1028	Lateral Swing-Away Bracket Knee - Left	\$247.00
Lateral Thigh Support Pads and Hardware (must pick pad and mount)			
250KF22	E0953	Lateral Thigh Support Pad Short - Right (5"x5")	\$135.00
250KF23	E0953	Lateral Thigh Support Pad Short - Left (5"x5")	\$135.00
250KF24	E0953	Lateral Thigh Support Pad Long - Right (5"x7")	\$135.00
250KF25	E0953	Lateral Thigh Support Pad Long - Left (5"x7")	\$135.00
250KF26	E1028	Lateral Thigh Removable Mount - Right	\$268.00
250KF27	E1028	Lateral Thigh Removable Mount - Left	\$268.00
JAY® Lateral Thigh Supports (Must pick pad, upholstery, and mount)			\$
JAY® Lateral Thigh Support Pads			
250KF16	E0953	Lateral Thigh Support Pad Standard, Right (8.25" x 3.25")	\$135.00
250KF17	E0953	Lateral Thigh Support Pad Standard, Left (8.25" x 3.25")	\$135.00
250KF18	E0953	Lateral Thigh Support Pad Large, Right (12" x 3.25")	\$135.00
250KF19	E0953	Lateral Thigh Support Pad Large, Left (12" x 3.25")	\$135.00
JAY® Lateral Thigh Support Pad Upholstery			
250NU07	–	Syncra™ Premium Leatherette	NC
250NU08	–	Syncra™ Stretch	NC
250NU09	–	Syncra™ 3DX Microclimatic	NC
JAY® Lateral Thigh Removable Mount			
250KF20	E1028	Lateral Thigh Removable Mount - Right	\$268.00
250KF21	E1028	Lateral Thigh Removable Mount - Left	\$268.00

POSITIONING SUPPORTS & ACCESSORIES

OPTION	HCPC	DESCRIPTION	RETAIL
Armrest Structure  P. 28			\$
250EG35	–	Reclining, Flip Back (<i>Height Adjustable 9" to 15"</i>)	NC
250EG36	–	Reclining, Flip Back with 2-point post locking arm (<i>Height Adjustable 11" to 15" x .625"</i>)	\$268.00
250EG32	–	Single Post, Flip Back (<i>N/A with thigh support</i>), (<i>Height Adjustable 10" to 15"</i>)	NC
250EG33	–	Single Post, Removable (<i>N/A with thigh support</i>), (<i>Height Adjustable 10" to 15"</i>)	NC
Arm Pads  P. 28			\$
SEDEO® Armrest Pad			
250AB43	–	300 mm / 12", Integral Foam, Right	NC
250AE43	–	300 mm / 12", Integral Foam, Left	NC
250AB44	–	400 mm / 16", Integral Foam, Right	NC
250AE44	–	400 mm / 16", Integral Foam, Left	NC
250AB45	–	Wide, 450 mm / 18", Integral Foam, Right (<i>Increases armpad width by 1.5". May prevent flip-back.</i>)	NC
250AE45	–	Wide, 450 mm / 18", Integral Foam, Left (<i>Increases armpad width by 1.5". May prevent flip-back.</i>)	NC
Comfort Arm Pad (Foam)			
250AB46	–	2" Wide Right	\$81.00
250AE46	–	2" Wide Left	\$81.00
250AB47	–	4" Wide Right	\$81.00
250AE47	–	4" Wide Left	\$81.00
Comfort Arm Pad (Gel)			
250AB48	–	2" Wide Right	\$161.00
250AE48	–	2" Wide Left	\$161.00
250AB49	–	4" Wide Right	\$161.00
250AE49	–	4" Wide Left	\$161.00
AES Trough/Elbow Block Arm Pads (Gel)			
250AB50	E2209	3.5" x 13" Right	\$268.00
250AE50	E2209	3.5" x 13" Left	\$268.00
250AB51	E2209	4" x 14.5" Right	\$268.00
250AE51	E2209	4" x 14.5" Left	\$268.00

POSITIONING SUPPORTS & ACCESSORIES

OPTION	HCPC	DESCRIPTION	RETAIL
Side Guards (Pair)			\$
250SG43	E0953	Side Guards (9"L x 5.5"H) (N/A with Reclining Armrests)	\$188.00
250SG44	E0953	Side Guards Integral Foam (11"L x 5.5"H) (N/A with Reclining Armrests)	\$220.00
250SG45	E0953	Side Guards Wedge Shaped, Padded (18"L x 5"H, 3" thick in front, 1.5" thick in rear) (Only with Single Post Removable Armrests)	\$220.00
250SG46	E0953	Side Guards Mounted On Seat Rail Bracket (Only with Reclining Armrests) (N/A with Thigh Supports)	\$242.00
Fixed Centermount Legrest			\$
250H183	–	SEDEO® Fixed Centermount Legrest (3" to 17.5" Leg Length)	\$268.00
250H184	–	Fixed Centermount Legrest, Short (Includes Calf Pads & Single Footplate) (11.5" to 14.5" Leg Length)	NC
250H185	–	Fixed Centermount Legrest, Long (Includes Calf Pads & Single Footplate) (13.5" to 18.5" Leg Length)	NC
Power Centermount Legrest  P. 28			\$
250H175	E1012	Power Centermount Legrest, 90° - 0° Angle, 7.5" Extension (Mechanical Articulation) (5" to 17.5" Leg Length)	\$2,490.00
250H109	E1012	Power Centermount Legrest, 90° - 0° Angle, 7.5" Extension (Powered Articulation) (3" to 17.5" Leg Length)	\$3,489.00
Power Centermount Legrest Accessories			\$
Footplates			
250F127	K0040	Dual, Height, Width and Angle Adjustable, Standard (14"W x 10"D)	\$182.00
250F128	K0040	Dual, Height, Width and Angle Adjustable, Large (16"W x 12"D)	\$182.00
Calf Pad Options			
250DI34	–	Calf Pads, Pair, Standard	NC
250DI35	E0995	Extra Large Pair Calf Pads for Centermount Legrests. Fully adjustable (N/A w/ Std footplate)	\$376.00
SEDEO® PRO™ Swing-Away Legrest (Pair)			\$
250H177	–	Legrests, Swing-Away, 70°, SEDEO® PRO™ (14" to 21" Leg Length)	NC
250H178	E0990	Legrests, Manual Elevating, Swing-Away, SEDEO® PRO™ (Includes Padded Calf Pads) (14".5 to 21.5" Leg Length)	\$376.00
250H179	E1010	Legrests, Power Elevating, Swing-Away, SEDEO® PRO™ (Includes Padded Calf Pads) (15.5" to 22.5" Leg Length)	\$2,308.00
250H180	–	Hanger Receivers Only, SEDEO® PRO™	NC
250DI76	–	Omit Legrests	NC
Swing-Away Legrest Footplates			
250F369	K0040	Angle Adjustable Flip-Up Footplates	\$182.00
Swing-Away Legrest Calf Supports			
250DI41	–	Calf Support, Depth Adjustable, Integral Foam (7" Wide x 10" Tall, NA 16-17" W)	\$317.00
250DI42	–	Calf Support, Depth Adjustable, Padded (6.5" to 8" Wide, Depending On Chair Width, x 9.5" Tall)	\$424.00
Swing-Away Legrest Options			
250F364	K0108	Footplates, Coupled	\$268.00
250DI44	E0951	Heel Loops	\$54.00
250DI40	–	Calf Strap (Only For 70° Swing-Away Legrests)	\$107.00
250KG4	–	Knee Pads, Integral Foam (2.5" Wide x 4.5" Tall)	\$215.00
SEDEO® Lower Extremity Swing-Away Support			
250VD01	E1020	Lower Extremity Support, Padded, Swing-Away, SEDEO®, Right	\$424.00
250VD02	E1020	Lower Extremity Support, Padded, Swing-Away, SEDEO®, Left	\$424.00

POSITIONING SUPPORTS & ACCESSORIES

OPTION	HCPC	DESCRIPTION	RETAIL
Pelvic Positioning Belts  P. 29			
250A837	–	Positioning Belt, Auto Style Buckle, 50 mm 1600 mm / 2"	NC
250A839	–	Positioning Belt, Aircraft Buckle, 50 mm x 1300 mm / 2"	NC
250A840	E0978	Positioning Belt, Aircraft Buckle, Padded 50 mm x 1300 mm / 2"	\$81.00

Accessories

\$

Ventilator Option

250VT12	E1029	Vent Tray Fixed (<i>Pulmonetic LTV Models</i>)	\$499.00
---------	-------	--	----------

O2 Tank Option

250A718	E2208	O2 Tank Holder Mounted to Backrest (<i>D and E Styles</i>)	\$349.00
---------	-------	--	----------

Wheelchair Tray Table

2507A09	E0950	Tray, Swing-Away	\$376.00
---------	-------	------------------	----------

Backpack

250A1	–	Black Utility	\$59.00
-------	---	---------------	---------

Misc. Accessories

2508A59	–	Transfer Bar (<i>Pair</i>)	\$376.00
2508A52	–	Ram Mount Phone	\$92.00
2508A53	–	Ram Mount Tablet	\$376.00
2508A54	–	Ram Mount Cup Holder	\$92.00
2508A58	–	Rear View Mirror	\$92.00

JOYSTICK / ELECTRONICS

OPTION	HCPC	DESCRIPTION	RETAIL
R-net Joystick (<i>Remote</i>)  P. 29			
250J121	–	Standard LED Joystick (<i>w/o Screen Display</i>)	NC
250J116	–	Color Joystick (<i>2.3" Color LCD Screen Display, CJSM1</i>)	NC
250J117	–	Heavy Duty Color Joystick (<i>2.3" Color LCD Screen Display, Fixed Joystick Mount Only</i>)	\$1,235.00
250J118	–	High Resolution Color Joystick, (CJSM2+BT) <i>3.5" Color LCD Display, Paddle Switches, Programmable Shortcut Keys, ICONs, Stereo Jack, IR and dual (IOS/Android) Bluetooth control</i>	\$1,132.00
250J119	–	Omit Remote Control (<i>Required with arm mounted specialty controls</i>)	–\$25.00

Joystick Mounting

\$

250JM34	–	Fixed on Armrest	NC
250JM35	E1028	Parallel Swing-Away	\$317.00
250JM36	E1028	Link-It Mid Line Mount on Armrest (<i>Swing-Away</i>)	\$913.00

Joystick Mount (Location)

\$

250HM16	–	Right Hand Armrest	NC
250HM17	–	Left Hand Armrest	NC

Display Language Selection R-net



\$

250L1	–	English	NC
250L3	–	French	NC
250L7	–	Spanish	NC

JOYSTICK / ELECTRONICS

OPTION	HCPC	DESCRIPTION	RETAIL
Joystick Handle (Optional) <i>N/A with HD Joystick</i>  P. 29			\$
250JH13	E2323	Ball Handle	\$135.00
250JH14	E2323	Foam Ball Handle	\$135.00
250JH15	E2323	T-Handle	\$135.00
250JH16	E2323	Goalpost	\$135.00
Electronic Programmers  P. 30			\$
250PR10	–	R-net PC Programmer w/ Dongle	\$564.00
R-net Power Modules  P. 30			\$
250ER11	–	Power Module, R-net, 120A, Non-Expandable <i>(Only available with Group 4)</i>	NC
250ER10	–	Power Module, R-net, 120A, Expandable <i>(Only available with Group 4)</i> <i>Required for specialty controls or 3+ actuators</i>	\$1,337.00
250EX09	E2377	Expandable 120A Controller - R-net	\$703.00
250EX10	E2313	Harness for 120A Expandable Controller	\$634.00
250ER18	–	Power Module, R-net, 90A, Non-Expandable	NC
250ER17	–	Power Module, R-net, 90A, Expandable <i>Required for specialty controls or 3+ actuators</i>	\$1,337.00
250EX15	E2377	Expandable 90A Controller - R-net	\$703.00
250EX16	E2313	Harness for 90A Expandable Controller	\$634.00
Seating Control			\$
Powered Seating Control			
250E040	–	Omit Thru-Drive <i>(Requires Switch Control)</i>	NC
250E037	E2310	Thru-Drive Control for 1 Actuator	\$2,061.00
250E038	E2311	Thru-Drive Control for 2+ Actuators	\$3,731.00
Switch Control <i>(Available with Omit Thru-Drive only) (1 actuator for Tilt or Elevate only)</i>			
250E033	–	Dual Toggle for 1 Actuator	NC
250E034	–	2.5" Single Button Switch for 1 Actuator <i>(Button switches are not mounted)</i>	NC
250E035	–	Switch-It Mini 1 button for 1 Actuator	NC
250E036	–	Switch-It Mini 2 button for 1 Actuator	NC
250E041	–	Ctrl+5 Switch Box for 2 Actuators or More	NC
Additional Power Seating Control <i>(Available with Thru-Drive only)</i>			
250QG11	–	Ctrl+5 Switch Box with Free Assignable Functions	\$1,342.00
250QG12	–	Ctrl+5 Switch Box with Free Assignable Functions <i>(Multi-power only)</i>	NC
Dual Toggle Mounting Location			
250TN1	–	Toggle Mount, Right	NC
250TN2	–	Toggle Mount, Left	NC

JOYSTICK / ELECTRONICS

OPTION	HCPC	DESCRIPTION	RETAIL
Ctrl+5 Mounting Location			
250EY19	–	Right Armrest	NC
250EY20	–	Left Armrest	NC
250EY21	–	Back Cane, Right	\$161.00
250EY24	–	Back Cane, Left	\$161.00
Ctrl+5 Switch Type			
250EY22	–	Push Buttons	NC
250EY23	K0108	Toggle Switches	\$322.00
Attendant Controls  P. 30 \$			
2500A05	E2331	Dual Control Module for Attendant	\$1,396.00
2500A06	E2331	R-net Color LCD (CJSM1), Attendant Control Only	\$1,396.00
Attendant Mounting Location \$			
250DN5	–	Right Back Cane	NC
250DN6	–	Left Back Cane	NC
R-net Programming \$			
Assignable Buttons			
<i>Assignable Button feature allows for personalization of joystick buttons and/or Ctrl+5 Switches allowing access to various wheelchair and seating functions. When enabled, chair will be pre-programmed with seating functions assigned to buttons on the joystick. Assignments can be changed via PC Dongle.</i>			
250PM12	–	Include Assignable Buttons	NC
Power Centermount Footplate Extension Option			
250IE03	K0108	Include 7.5" Powered Footplate Extension for Transfer Assist (<i>Electronics programmed to allow footplates to be extended with or without legrest being raised.</i>) Only available with Powered Articulation.	\$1,342.00
R-net Omni2 Options  P. 30 <i>For Expandable Controls, choose all that apply.</i> \$			
2500N14	–	R-net Omni2 Only Input Control Module and 3.5" LCD Display w/ Built-In Infrared & Bluetooth Choose Mount Below	\$1,906.00
2500N15	–	R-net Omni2 Bundled Input Control Module and 3.5" LCD Display w/ Built-In Infrared & Bluetooth Bundled Omni2 Available w/ Switch-It Input Devices	NC
Omni2 Mount <i>If used w/ Standard Joystick, it must be mounted opposite side.</i> \$			
250DS14	E1028	Link-It with Parallel Swing-Away Omni2 Mount w/ Rear Mounted Interface, Right	\$532.00
250DS15	E1028	Link-It with Parallel Swing-Away Omni2 Mount w/ Rear Mounted Interface, Left	\$532.00

SPECIALTY INPUT DEVICES

OPTION	HCPC	DESCRIPTION	RETAIL
Hand Control Packages  P. 31 <i>Requires Standard Joystick Omit / Only one hand control device can be ordered.</i>			\$
Proportional Input Devices			
250EU14	E2312	Switch-It MicroGuide	\$3,537.00
250EU15	E2312	Switch-It MicroPilot	\$3,537.00
250EU16	K0108	Switch-It TouchDrive 2	\$4,128.00
250EU17	E2328	Switch-It VersaGuide	\$1,948.00
250EU18	E2328	Switch-It VersaGuide EZ	\$2,303.00
Mounting Position (Required)			
250EM04	E1028	Link-It to the Backrest <i>(Not Available w/ Omit Back Cushion Type)</i>	\$1,020.00
250EM05	E1028	Link-It to the Fixed Joystick Mount	\$317.00
250EM06	E1028	Link-It to the Parallel Swing-Away Joystick Mount	\$532.00
250EM07	E1028	Link-It to the Midline Swing-Away	\$1,127.00
250EM08	E1028	Omit Mount	NC
Mounting Platforms (Optional) <i>Not available w/ Link-It to Backrest</i>			
250MG16	E0950	SunDisk Hand Tray <i>(Only available w/ MicroSeries Joysticks)</i>	\$317.00
250MG15	E0950	Bullet Hand Tray	\$317.00
Mounting Location (Required)			
250IM09	–	Right	NC
250IM10	–	Left	NC
Switch Options			
–	–	See Switch Selections <i>(Maximum 2)</i>	–

SPECIALTY INPUT DEVICES

OPTION	HCPC	DESCRIPTION	RETAIL
--------	------	-------------	--------

Head Control Packages  P. 30 *(Select headrest mount on next page)* \$

Only one head control device can be ordered.

Proportional Input Devices

250EU25	E2328	Switch-It DualPro® Proportional Head Array - Facial Pads	\$6,135.00
250EU44	E2328	Switch-It DualPro® Proportional Head Array - Facial Pads - Dedicated Mode Outer Left	\$6,436.00
250EU45	E2328	Switch-It DualPro® Proportional Head Array - Facial Pads - Dedicated Mode Outer Right	\$6,436.00
250EU46	E2328	Switch-It DualPro® Proportional Head Array - Facial Pads - Dedicated Mode & Reverse	\$6,651.00
250EU26	E2328	Switch-It DualPro® Proportional Head Array - Spot Pads	\$6,135.00
250EU27	E2328	Switch-It RIM Proportional Head Control	\$6,329.00

Switched Input Devices

250EU28	E2330	Switch-It 3-Switch Head Array - Short Curved Wings	\$4,718.00
250EU29	E2330	Switch-It 3-Switch Head Array - Short Straight Wings	\$4,718.00
250EU30	E2330	Switch-It 3-Switch Head Array - Long Curved Wings	\$4,718.00
250EU31	E2330	Switch-It 3-Switch Head Array - Long Straight Wings	\$4,718.00
250EU42	E2330	Switch-It 4-Switch Head Array - Long Straight Wings Only - Mode Outer Left	\$4,933.00
250EU43	E2330	Switch-It 4-Switch Head Array - Long Straight Wings Only - Mode Outer Right	\$4,933.00
250EU33	E2330	Switch-It 5-Switch Head Array - Long Straight Wings Only - Mode Outer Left	\$5,073.00
250EU47	E2330	Switch-It 5-Switch Head Array - Long Straight Wings Only - Mode Outer Right	\$5,073.00

Switch Options

–	–	See Switch Selections <i>(Maximum 2)</i>	–
---	---	--	---

Sip 'N Puff \$

250ID73	E2330	Switch-It Sip 'N Puff Combo Head Array with Link-It Hardware <i>(Requires headrest mount)</i>	\$5,362.00
250ID74	K0108	Switch-It OptiStop with Sip 'N Puff	\$2,088.00

Headrest Mounts *(Applies to Head/Sip 'N Puff control packages)* \$

250IJ13	E1028	Whitmyer® Linx Headrest Mount w/ Quick Release	\$177.00
250IJ14	E1028	Whitmyer® Linx-2 Headrest Mount w/ Quick Release	\$215.00
250IJ15	E1028	Whitmyer® AXYS Headrest Mount with Quick Release	\$113.00
250IJ16	E1028	Whitmyer® AXYS Offset Headrest Mount with Quick Release	\$135.00
250IJ17	E1028	Whitmyer® Cobra FB Headrest Mount with Quick Release	\$322.00

SPECIALTY INPUT DEVICES

OPTION	HCPC	DESCRIPTION	RETAIL
--------	------	-------------	--------

Chin Control Packages  P. 31

\$

Proportional Input Devices

250EU34	E2312	Switch-It MicroGuide <i>(Switches mounted to the headrest only.)</i>	\$3,537.00
250EU35	E2312	Switch-It MicroPilot <i>(Switches mounted to the headrest only.)</i>	\$3,537.00
250EU36	E2328	Switch-It VersaGuide	\$1,948.00
250EU37	E2328	Switch-It VersaGuide EZ	\$2,303.00

Mounting Position

250EM09	E1028	Link-It To Chin Harness, Small (150mm / 6")	\$1,342.00
250EM10	E1028	Link-It To Chin Harness, Large (220mm / 8")	\$1,342.00
250EM11	E1028	Link-It To Headrest (Swing-Away)	\$1,342.00
250EM53	E1028	Link-It To Manual Chin Boom - Right Side	\$4,074.00
250EM54	E1028	Link-It To Manual Chin Boom - Left Side	\$4,074.00
250EM16	E1028	Omit Mount	NC

Input Device Mounting Location

250IM13	–	Right	NC
250IM14	–	Left	NC

Switch Options

–	–	See Switch Selections	–
---	---	-----------------------	---

Safety Devices

\$

250SA06	–	Switch-It Remote Stop Switch - XLR Connector	\$1,004.00
---------	---	--	------------

Switched Driving Packages

\$

250SW44	E2328	Switch-It™ Cool Cube with DB9 connector for proximity/proportional switch driving. <i>(Pro Spot proportional switches are required if proportional driving is desired.)</i> <i>(For non-proportional driving, single switches can be used.)</i>	\$3,725.00
---------	-------	---	------------

SPECIALTY INPUT DEVICES

OPTION	HCPC	DESCRIPTION	RETAIL
--------	------	-------------	--------

Switches  P. 30

Single switches can be programmed to activate any function of the wheelchair including: On/Off, Mode, Profile, Speeds, Seating, Memory Positions, Horn, Lights & Indicators, IR functions, Bluetooth mouse clicks, Environmental Controls when plugged into assignable port.

Switches can connect via: Joysticks (Standard, Micro series, Versa series) Omni2, SJX6 Hub, head controls

Switch ordering instructions:

1. Select switch type and quantity in Section "A" using columns below. (Max 6 switches. See limitations below.)
2. Select switch mounting position from Section "B" using corresponding switch column.
3. Select switch mounting location from Section "C" using corresponding switch column.

Section A – Switch Selections

Switch / Quantity

Single Function Switches - Mechanical Switches	Switch 1	Switch 2	Switch 3	Switch 4	Switch 5	Switch 6	\$
2.5" Single Switch - Black							\$209.00
2.5" Single Switch - Blue							\$209.00
2.5" Single Switch - Green							\$209.00
2.5" Single Switch - Red							\$209.00
2.5" Single Switch - Yellow							\$209.00
Egg Switch - Black							\$118.00
Egg Switch - Blue							\$118.00
Egg Switch - Green							\$118.00
Egg Switch - Red							\$118.00
Egg Switch - Yellow							\$118.00
MicroLite <i>(Includes color labels)</i>							\$177.00
Mini Button 1 - Blue <i>(Velcro)</i>							\$113.00
Mini Button 1 - Green <i>(Velcro)</i>							\$113.00
Mini Button 1 - Red <i>(Velcro)</i>							\$113.00
1" Single Switch - Black							\$296.00
1" Single Switch - Blue							\$296.00
1" Single Switch - Green							\$296.00
1" Single Switch - Orange							\$296.00
1" Single Switch - Red							\$296.00
1" Single Switch - Yellow							\$296.00
Twister Switch - Black <i>(Must choose mount and location)</i>							\$188.00
Twister Switch - Green <i>(Must choose mount and location)</i>							\$188.00
Twister Switch - Red <i>(Must choose mount and location)</i>							\$188.00
Electronic Switches							
Flex Switch (Headrest mount only)							\$230.00
Zero Touch Proximity Sensor							\$209.00
ProSpot - Proportional Switches							
ProSpot Proportional Switch - Red							\$510.00
ProSpot Proportional Switch - Green							\$510.00
ProSpot Proportional Switch - Blue							\$510.00
ProSpot Proportional Switch - Yellow							\$510.00
ProSpot Proportional Switch - Orange							\$510.00
Section B – Switch Mounting Position							
Link-It to the Backrest <i>(Up to 1 per side)</i>							\$698.00
Link-It to the Headrest - Gooseneck & Rigid <i>(Up to 2 per side)</i>							\$698.00
Link-It to the Fixed Joystick Mount <i>(Up to 2 per side)</i>							\$532.00
Link-It to the Parallel Swing-Away Joystick Mount <i>(Up to 2 per side)</i>							\$532.00
Link-It to the Seat Rail <i>(Up to 2 per side)</i> <i>(Not avail w/knee & thigh supports)</i>							\$424.00
Omit Mount <i>(includes Velcro)</i>							NC

Section C – Switch Mounting Location

Right side of chair								\$263.00
Left side of chair								\$263.00

Joystick Integrated Switches (Pair)

250J003	–	Proximity Switches on Flex Mount, Pair <i>(Used with VersaGuide/VersaGuide EZ)</i>						\$1068.00
---------	---	--	--	--	--	--	--	-----------

Additional Switches (Velcro)

250SA08	K0108	Mini 2 - Button <i>(Stereo Plug)</i>						\$258.00
250SA09	K0108	Mini 2 - Button <i>(Dual Mono Plug)</i>						\$258.00
250SA10	K0108	Mini 4 - Button In-Line <i>(DB9 connector)</i>						\$585.00

JAY® SYNCRA™ SEATING MEASURING GUIDE

JAY® SYNCRA™ BACK



Backrest Width	16"	18"	20"	22"
Max User Trunk Width	13.5"	15.5"	17.5"	19.5"

JAY® Swing-Away Lateral Thoracic Adjustment Range

Syncra Back Width	Width Range	Height range from bottom of shell to seat pan
16"	10" to 24"	12" to 19.5"
18"	12" to 26"	12.5" to 21.5"
20"	14" to 28"	12.5" to 22"
22"	16" to 30"	13.5" to 23"

Syncra™ Fixed Lateral Support Accessory Range

Syncra Back Width	Width Range	Height range from bottom of shell to seat pan	Contour Depth Range
16"	16.4" to 16.8"	6" to 8"	3" to 5"
18"	18.4" to 18.8"	6" to 8"	3" to 5"
20"	20.4" to 20.8"	6" to 8"	3" to 5"
22"	22.4" to 22.8"	6" to 8"	3" to 5"

Syncra™ Back Shell Height Diagram

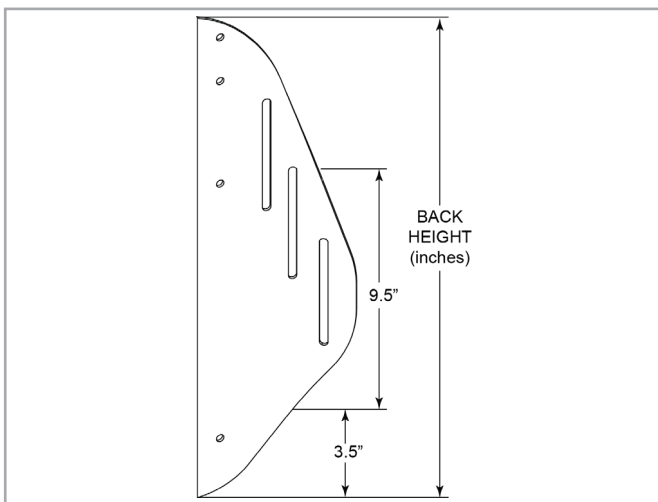

JAY® SYNCRA™ CUSHION



JAY® Lateral Thigh Support Adjustment Range

Syncra Cushion Width	Width Range
16"	8.5" to 16.0"
17"	9.5" to 17.0"
18"	10.5" to 18.0"
19"	11.5" to 19.0"
20"	12.5" to 20.0"
22"	14.5" to 22.0"

POWER BASE

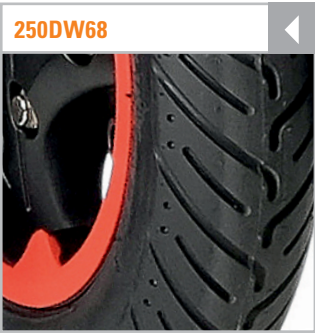

250DW68
14" Drive Wheel, Pneumatic, V-Type

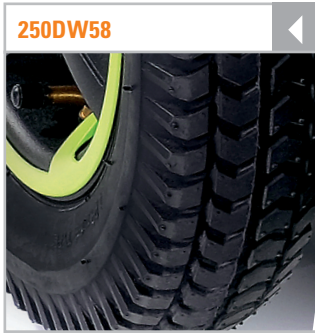

250DW58
14" Drive Wheel, Knobby



250CW55
6" Caster Wheels

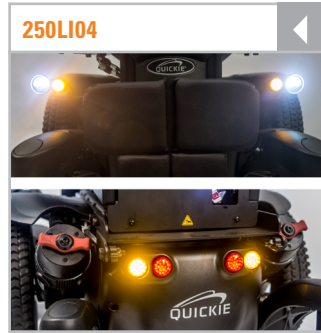

250LI04
LED Lights



250BJ28
Charger

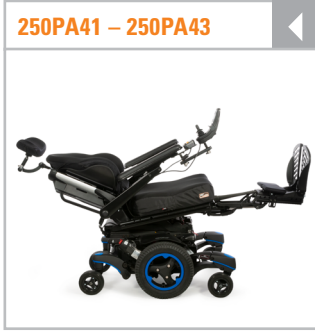

250PA41 – 250PA43
Power Seating: Tilt, Recline

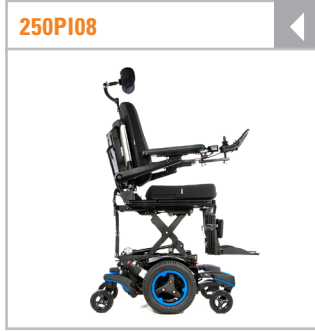

250PI08
Power Seating: Elevate

SEATING AND POSITIONING



250JP01 & 250JP02
JAY® J3® Back: 2.2"



250JP11
JAY® J3® Back: 3"



250JP13
JAY® J3® Back: 6"



250K10 – 250K12
JAY® Anterior Thoracic Support



250JS02 – 250JS04
JAY® J3® Back, Spine-Align Kit 2



250ST79
SEDEO® Cushion

SEATING AND POSITIONING

250CU59 – 250CU60



JAY® Ion® Cushion

250CU61 – 250CU62



JAY® Union® Cushion

250CU66 – 250CU69



JAY® Fusion® Cushion w/Air

250CU64 – 250CU65



JAY® Fusion® Cushion w/Fluid

250CU55



JAY® X2® Cushion

250CU56



JAY® J2® Cushion

250CU57 – 250CU58



JAY® J2® Deep Contour Cushion

250EG35



SEDEO® PRO™ Reclining Flip Back Armrest

250EG33



SEDEO® PRO™ Single Post Removable Armrest

250AB47



Comfort Reclining Armpad, Foam

250AB43



SEDEO® Reclining Armrest Pad

250AB48



Comfort Reclining Armpad, Gel

250H109







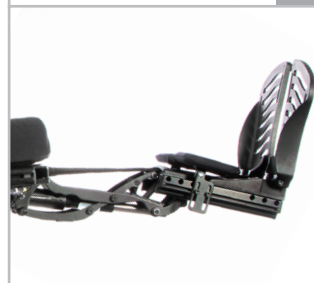



Power Centermount Legrest, Power Articulation

250H175



Power Centermount Legrest, Mechanical Articulation

SEATING AND POSITIONING

<p>250A837 – 250A840</p> 	<p>250HE36</p> 	<p>250HE37</p> 	<p>250MH32</p> 
<p>Positioning Belt, Aircraft Style</p>	<p>SEDEO® Headrest, Small</p>	<p>SEDEO® Headrest, Flexible</p>	<p>SEDEO® Multiposition Headrest Mount</p>
<p>250HE38 – 250HE44</p> 	<p>250HE45 – 250HE47</p> 	<p>250MH33</p> 	<p>250MH34</p> 
<p>Whitmyer® Plush Headrest</p>	<p>Whitmyer® Adjust-a-Plush Headrest</p>	<p>Whitmyer® Linx Headrest Mount</p>	<p>Whitmyer® Linx-2 Headrest Mount</p>

ELECTRONICS

<p>250J116</p> 	<p>250J117</p> 	<p>250J118</p> 	
<p>Color Joystick</p>	<p>Heavy Duty Color Joystick</p>	<p>High Resolution Color Joystick, (CJSM2+BT)</p>	
<p>250JH16</p> 	<p>250JH15</p> 	<p>250JH14</p> 	<p>250JH13</p> 
<p>Goalpost Joystick Handle</p>	<p>T-Handle Joystick Handle</p>	<p>Foam Ball Joystick Handle</p>	<p>Ball Joystick Handle</p>

ELECTRONICS

250PR10



R-net PC Programmer

250ER10



R-net Power Module

2500A05



Attendant Control

250EY22



Ctrl+5®, Push Button

250EY23



Ctrl+5®, Toggle

2500N14



R-net Omni2

250EU28 – 250EU31



Switch-It™ Head Array

250EU25 – 250EU26



Switch-It™ Dual Pro® Proportional Head Array

250EU27



Switch-It™ RIM Proportional Head Control

ELECTRONICS



Switch-It™ MicroGuide



Switch-It™ MicroPilot



Switch-It™ VersaGuide



Switch-It™ TouchDrive 2 (TD2)



All Round Joystick, Light



All Round Joystick, Standard



Link-It to Backrest

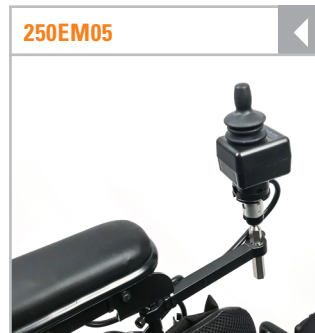

Link-It to Fixed Joystick Mount

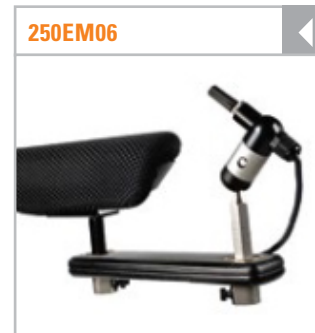

Link-It to Parallel Swing-Away Joystick Mount

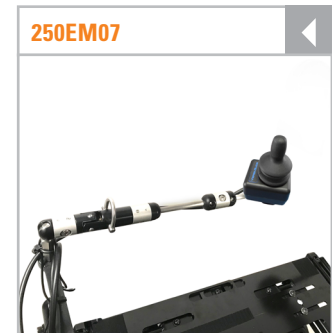

Link-It to Midline Swing-Away Joystick Mount

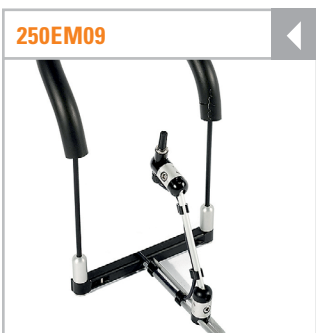

Link-It to Chin Harness

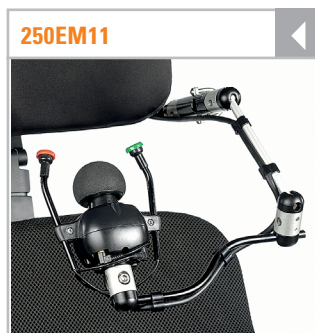

Link-It to Headrest, Swing-Away



Link-It to Manual Chin Boom



Link-It to Power Chin Boom

ELECTRONICS

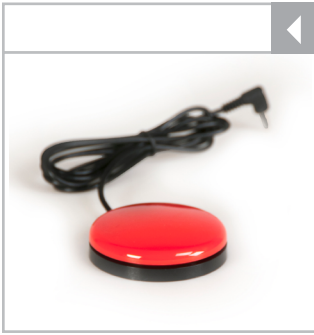

2.5" Single Switch
black, blue, green, red, yellow

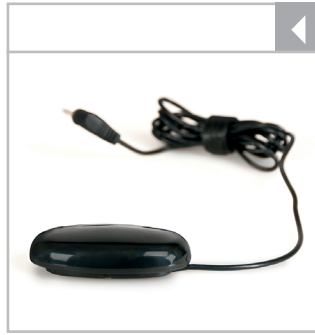

Egg Switch
black, blue, green, red, yellow



MicroLite



1" Single Switch
black, blue, green, orange, red,
yellow

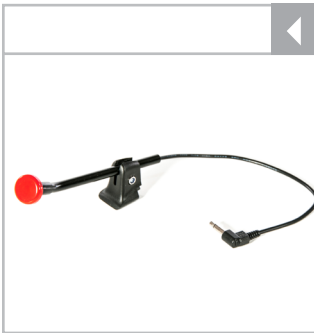

Twister Switch
black, green, red

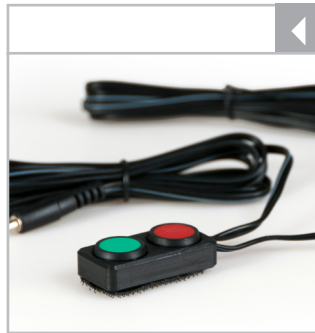

Mini 2



Mini 4



Mini 1 Button (Mono Plug)
blue, green, red



Q700 M with SEDEO® PRO™ \$

Base Price	
Total of additional equipment	
Packaging and transport	
Total Price	

Date	Signature
------	-----------

Month Day Year

