

Catalyst 5 Footplates - Composite

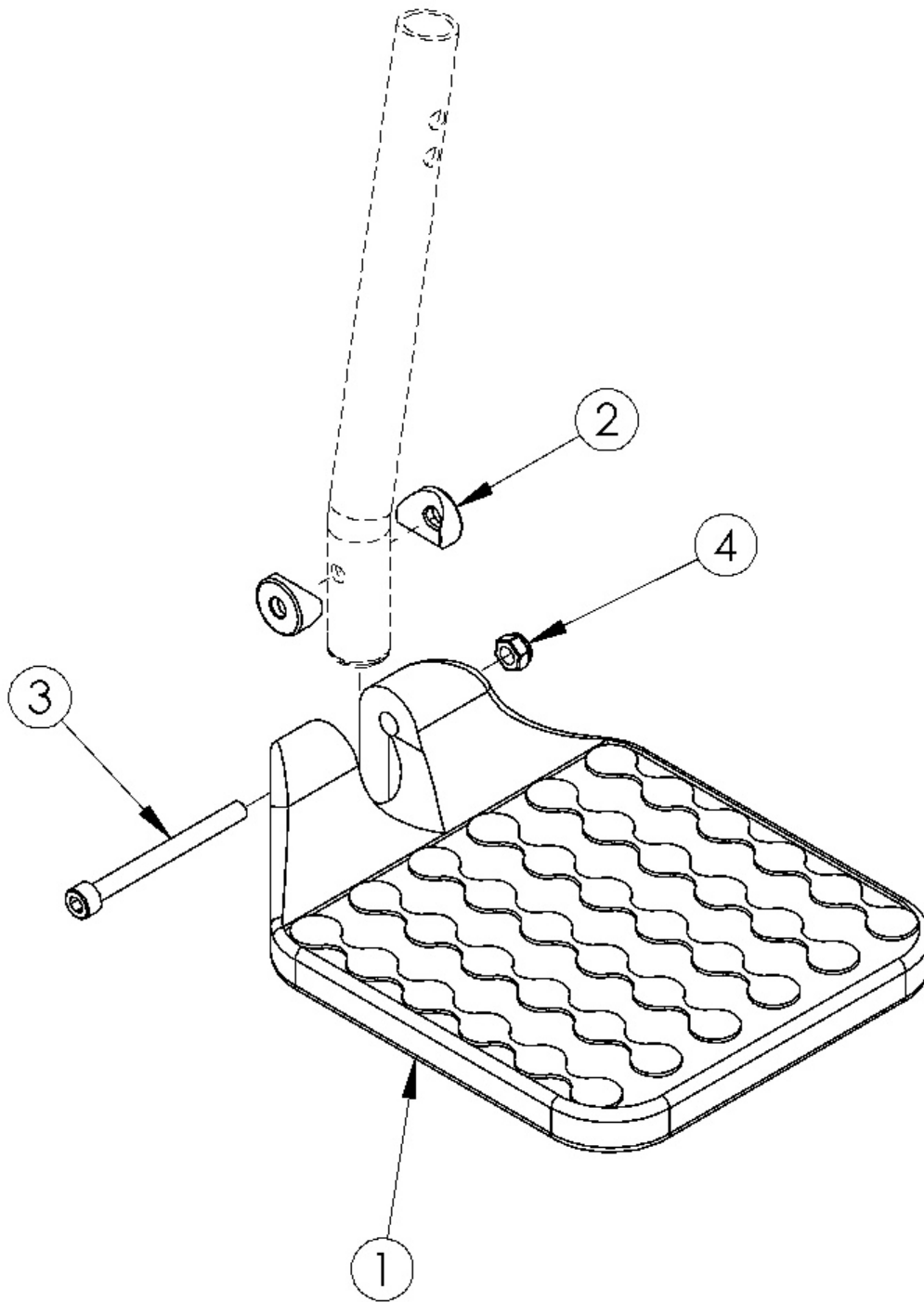

Sizes for footplates are based on seat width.

Item Number	Part Number	Description	Quantity	Retail
2-4	112895	Hardware Assembly for Composite Footplate	1	\$6.19
1a	100537	Footplate Composite 14-15" Wide CAT/TILT	1	\$36.77
1b	100540	Footplate Composite 16-17" Wide CAT/TILT	1	\$36.77
1c	100542	Footplate Composite 18-24" Wide CAT/TILT	1	\$36.77
2	000053	Saddle 3/4"	2	\$1.58
3	101849	M6 x 65 SHCS Blk Zn	1	\$2.10
4	100658	M6 Nylock Nut Blk Zn	1	\$1.05