

Catalyst 4 Footplates - Composite

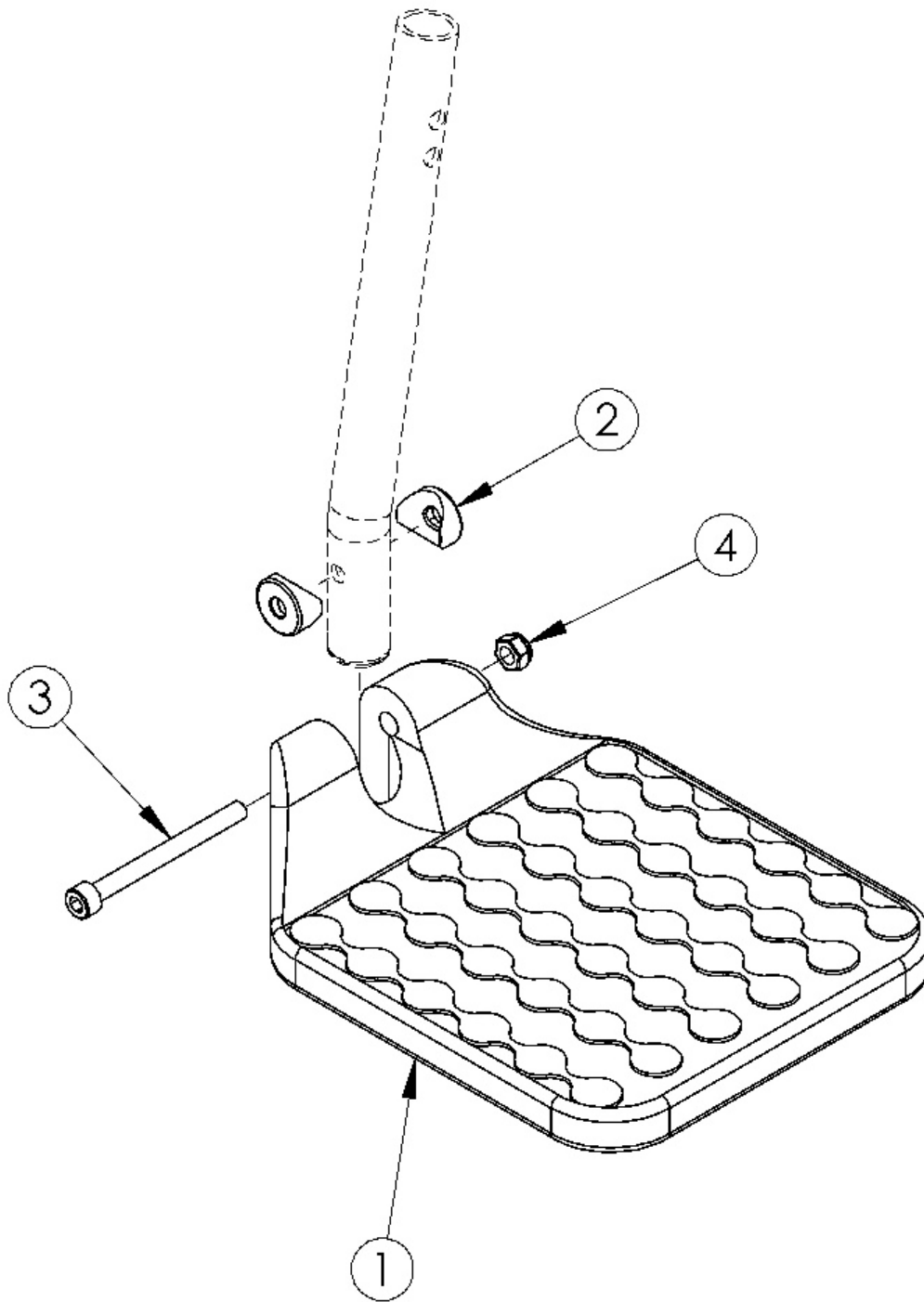

Sizes for footplates are based on seat width. Only compatible with extension tube hangers. If changing footplate style, new extension tubes may be needed.

Item Number	Part Number	Description	Quantity
2-4	112895	Hardware Assembly for Composite Footplate	1
1a	100537	Footplate Composite 14-15" Wide CAT/TILT	1
1b	100540	Footplate Composite 16-17" Wide CAT/TILT	1
1c	100542	Footplate Composite 18-24" Wide CAT/TILT	1
2	000053	Saddle 3/4"	2
3	101849	M6 x 65 SHCS Blk Zn	1
4	100658	M6 Nylock Nut Blk Zn	1