

# Focus CR Dual Hand Tilt Mechanism Fixed Height with Adjustable Handle Back

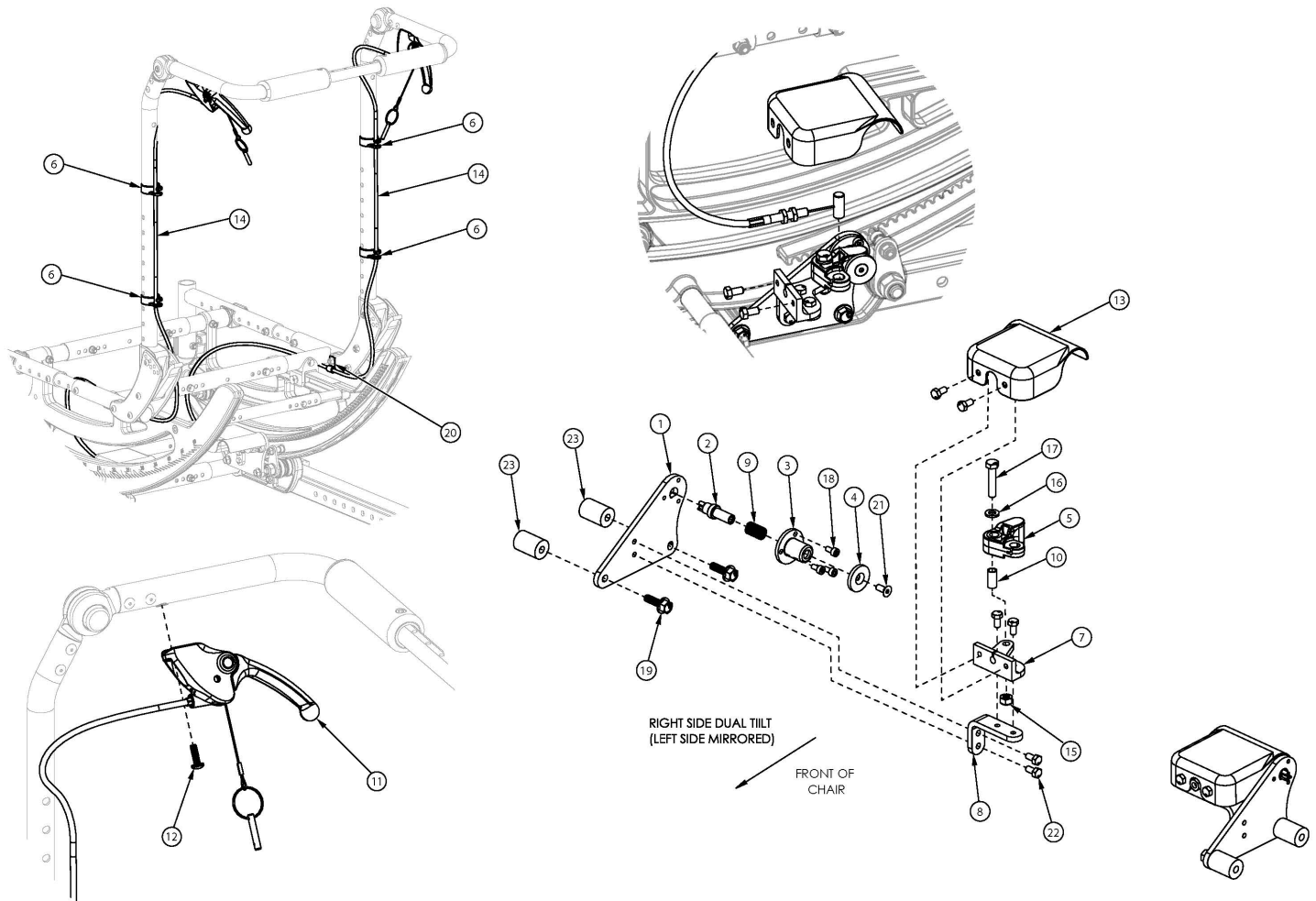

This design effective starting with serial numbers FCR0026599 and FCHD002333. <p>

If serial number is prior to FCR0026599 and FCHD002333 new back cane assemblies are required in addition to the hand tilt mechanism.

Item Number	Part Number	Description	Quantity	Retail
1-5, 7a, 7b, 8-10, 13, 15-18, 19a, 21, 22	506274	Dual Tilt Lock Mechanism Kit, Focus <i>For complete dual hand tilt mechanism, select appropriate Hand Tilt Cable/Trigger Kit in addition to this kit</i>	1	\$443.14
1-5, 7a, 7b, 8-10, 13, 15-18, 19b, 21-23	506275	Dual Tilt Lock Mechanism Kit, Heavy Duty, Focus <i>For complete dual hand tilt mechanism, select appropriate Hand Tilt Cable/Trigger Kit in addition to this kit</i>	1	\$555.77
6, 11, 12, 14a, 20	506786	Hand Tilt Cable/Trigger Kit with XL Cable, Fixed Height w/Adjustable Handle, Focus <i>Used with Short Fixed Height with Adjustable Handle</i>	2	\$164.34
6, 11, 12, 14b, 20	506787	Hand Tilt Cable/Trigger Kit with XXL Cable, Fixed Height w/Adjustable Handle, Focus	2	\$164.78

Item Number	Part Number	Description	Quantity	Retail
		<i>Used with Tall Fixed Height with Adjustable Handle</i>		
1	004280	Mount Plate, Tilt Lock	2	\$14.49
2	004281	Pin, Plunger, Tilt Lock	2	\$61.67
3	004282	Housing, Plunger, Tilt Lock	2	\$10.51
4	004283	Thrust Washer, Tilt Lock	2	\$7.25
5	004284	Cam Lever, Drive, Tilt Lock	2	\$32.35
1-5, 7a, 8-10, 13, 15-18, 19a, 21, 22	506276	Tilt Lock Mechanism Dual Hand, Right	1	\$221.57
1-5, 7b, 8-10, 13, 15-18, 19a, 21, 22	506277	Tilt Lock Mechanism Dual Hand, Left	1	\$221.57
1-5, 7a, 8-10, 13, 15-18, 19b, 21-23	506278	Tilt Lock Mechanism Dual Hand, Heavy Duty Right	1	\$277.89
1-5, 7b, 8-10, 13, 15-18, 19b, 21-23	506279	Tilt Lock Mechanism Dual Hand, Heavy Duty Left	1	\$277.89
6	001117	Cable Clip 1"	4	\$3.83
7a	004287	Linkage Mount, Right	1	\$46.23
7b	004288	Linkage Mount, Left	1	\$46.23
8	004289	Bracket, Mount, Tilt Lock	2	\$15.54
9	004290	Spring, Comp, .42OD x 1.0L x .038W	2	\$1.05
10	004291	Bushing, Pivot, Tilt Lock	2	\$6.83
11	003492	Lever Assembly, Straight	2	\$24.95
12	100734	M5 x 16 PHMS ZC	2	\$1.58
13	004298	Cover, Tilt Lock	2	\$13.03
14a	004303	Cable, Tilt, XL <i>Used with Short Fixed Height with Adjustable Handle</i>	2	\$110.31
14b	004304	Cable, Tilt, XXL <i>Used with Tall Fixed Height with Adjustable Handle</i>	2	\$112.41
15	100658	M6 Nylock Nut Blk Zn	2	\$1.05
16	100746	M6 Flat Washer Blk Zn	2	\$1.58
17	101824	M6 x 30 HHCS Blk Zn	2	\$2.10
18	102800	M4 x 8mm SHCS Blk Zn	6	\$0.53

Item Number	Part Number	Description	Quantity	Retail
19a	103510	M6 x 1 x 20 HHCS SFLG CLS8.8 Blk Zn DIN6921 <i>Used with Standard Weight Capacity</i>	4	\$1.05
19b	103511	M6 x 1 x 45 HHCS SFLG CLS8.8 Blk Zn DIN6921 <i>Used with Heavy Duty Option</i>	4	\$3.15
20	001239	P-Clip 3/16"	2	\$6.30
21	103522	M5 x 0.8 x 12 FHCS CLS 10.9 Nyl Blk Zn DIN7991	2	\$1.05
22	200427	M5 x 10 CLS8.8 HHCS ZC w/Patch DIN933	12	\$0.53
23	001405	Spacer, .69OD x .24ID x .1.01Lg <i>Used with Heavy Duty Option</i>	4	\$26.05