

# OMRON®

## INSTRUCTION MANUAL

# 5 series Upper Arm Blood Pressure Monitor

Model BP7250



ENGLISH

3608778-6J

# Table of Contents

Introduction .....	3
Important Safety Information .....	5
1. Know Your Monitor .....	11
2. Preparation .....	19
3. Using Your Monitor without a Smart Device .....	25
4. Using Your Monitor with a Smart Device .....	28
5. Using Memory Function .....	31
6. Other Settings .....	33
7. Error Messages and Troubleshooting .....	35
8. Maintenance .....	40
9. Optional Accessories .....	42
10. Specifications .....	44
11. FCC Statement .....	47
12. Limited Warranty .....	49
13. Guidance and Manufacturer's Declaration .....	51

# Introduction

Thank you for purchasing the OMRON BP7250 Blood Pressure Monitor. This monitor can be used by multiple users. This blood pressure monitor uses the oscillometric method of blood pressure measurement. This means this monitor detects your blood movement through your brachial artery and converts the movements into a digital reading.

## Safety Instructions

This instruction manual provides you with important information about the OMRON BP7250 Blood Pressure Monitor. To ensure the safe and proper use of this monitor, READ and UNDERSTAND all of these instructions. **If you do not understand these instructions or have any questions, contact 1-800-634-4350 before attempting to use this monitor. For specific information about your own blood pressure, consult with your physician.**

## Intended Use

This device is a digital monitor intended for use in measuring blood pressure and pulse rate in adult patient population. The device detects the appearance of irregular heartbeats during measurement and gives a warning signal with readings.

Environments of Use: Home

Patient Population: Adult

## Receiving and Inspection

Remove this monitor and other components from the packaging and inspect for damage. If this monitor or any other components is damaged, DO NOT USE and contact 1-800-634-4350.

## **Symbols Glossary**

For symbol information, visit:

[OmronHealthcare.com/symbols-glossary](http://OmronHealthcare.com/symbols-glossary)

## **Contraindications**

---

- This monitor is contraindicated for use in ambulatory environments.
  - This monitor is contraindicated for use on aircraft.
-

## Important Safety Information

**Read the Important Safety Information in this instruction manual before using this monitor.**

Follow this instruction manual thoroughly for your safety.

Keep for future reference. For specific information about your own blood pressure, **CONSULT WITH YOUR PHYSICIAN.**

### **Warning**

Indicates a potentially hazardous situation which, if not avoided, could result in death or serious injury.

- **DO NOT use this monitor on infants, toddlers, children or persons who cannot express themselves.**
- **DO NOT adjust medication based on readings from this blood pressure monitor. Take medication as prescribed by your physician. ONLY a physician is qualified to diagnose and treat high blood pressure.**
- **DO NOT use this monitor on an injured arm or an arm under medical treatment.**
- **DO NOT apply the arm cuff on your arm while on an intravenous drip or blood transfusion.**
- **DO NOT use this monitor in areas containing high frequency (HF) surgical equipment, magnetic resonance imaging (MRI) equipment, computerized tomography (CT) scanners. This may result in incorrect operation of the monitor and/or cause an inaccurate reading.**
- **DO NOT use this monitor in oxygen rich environments or near flammable gas.**
- **Consult with your physician before using this monitor if you have common arrhythmias such as atrial or ventricular premature beats or atrial fibrillation; arterial sclerosis; poor perfusion; diabetes; pregnancy; pre-eclampsia or renal disease. NOTE that any of these conditions in addition to patient motion, trembling, or shivering may affect the measurement reading.**

- **NEVER** diagnose or treat yourself based on your readings. **ALWAYS** consult with your physician.
- To help avoid strangulation, keep the air tube and AC adapter cable away from infants, toddlers and children.
- This product contains small parts that may cause a choking hazard if swallowed by infants, toddlers and children.

#### **Data Transmission**

- This product emits radio frequencies (RF) in the 2.4 GHz band. **DO NOT** use this product in locations where RF is restricted, such as on an aircraft or in hospitals. Turn off the Bluetooth® feature in this monitor, remove batteries and/or unplug the AC adapter when in RF restricted areas. For further information on potential restrictions refer to documentation on the Bluetooth usage by the FCC.

#### **AC Adapter (optional accessory) Handling and Usage**

- **DO NOT** use the AC adapter if this monitor or the AC adapter cable is damaged. If this monitor or the cable is damaged, turn off the power and unplug the AC adapter immediately.
- Plug the AC adapter into the appropriate voltage outlet. **DO NOT** use in a multi-outlet plug.
- **NEVER** plug in or unplug the AC adapter from the electric outlet with wet hands.
- **DO NOT** disassemble or attempt to repair the AC adapter.

#### **Battery Handling and Usage**

- Keep batteries out of the reach of infants, toddlers and children.
- 

 **Caution** Indicates a potentially hazardous situation which, if not avoided, may result in minor or moderate injury to the user or patient, or cause damage to the equipment or other property.

---

- Stop using this monitor and consult with your physician if you experience skin irritation or discomfort.
- Consult with your physician before using this monitor on an arm where intravascular access or therapy, or an arterio-venous (A-V) shunt, is present because of temporary interference to blood flow which could result in injury.

- **Consult with your physician before using this monitor if you have had a mastectomy.**
- **Consult with your physician before using this monitor if you have severe blood flow problems or blood disorders as cuff inflation can cause bruising.**
- **DO NOT take measurements more often than necessary because bruising, due to blood flow interference, may occur.**
- **ONLY inflate the arm cuff when it is applied on your upper arm.**
- **Remove the arm cuff if it does not start deflating during a measurement.**
- **DO NOT use this monitor for any purpose other than measuring blood pressure.**
- **During measurement, make sure that no mobile device or any other electrical device that emits electromagnetic fields is within 12 inches (30 cm) of this monitor. This may result in incorrect operation of the monitor and/or cause an inaccurate reading.**
- **DO NOT disassemble or attempt to repair this monitor or other components. This may cause an inaccurate reading.**
- **DO NOT use in a location where there is moisture or a risk of water splashing this monitor. This may damage this monitor.**
- **DO NOT use this monitor in a moving vehicle such as in a car.**
- **DO NOT drop or subject this monitor to strong shocks or vibrations.**
- **DO NOT use this monitor in places with high or low humidity or high or low temperatures. Refer to section 10.**
- **During measurement, observe the arm to ensure that the monitor is not causing prolonged impairment to blood circulation.**
- **DO NOT use this monitor in high-use environments such as medical clinics or physician offices.**
- **DO NOT use this monitor with other medical electrical (ME) equipment simultaneously. This may result in incorrect operation of the monitor and/or cause an inaccurate reading.**
- **Avoid bathing, drinking alcohol or caffeine, smoking, exercising and eating for at least 30 minutes before taking a measurement.**
- **Rest for at least 5 minutes before taking a measurement.**

- **Remove tight-fitting or thick clothing from your arm while taking a measurement.**
- **Remain still and DO NOT talk while taking a measurement.**
- **ONLY use the arm cuff on persons whose arm circumference is within the specified range of the cuff.**
- **Ensure that this monitor has acclimated to room temperature before taking a measurement. Taking a measurement after an extreme temperature change could lead to an inaccurate reading. OMRON recommends waiting for approximately 2 hours for the monitor to warm up or cool down when the monitor is used in an environment within the temperature specified as operating conditions after it is stored either at the maximum or at the minimum storage temperature. For additional information on operating and storage/transport temperature, refer to section 10.**
- **DO NOT use this monitor after the durable period has ended. Refer to section 10.**
- **DO NOT crease the arm cuff or the air tube excessively.**
- **DO NOT fold or kink the air tube while taking a measurement. This may cause an injury by interrupting blood flow.**
- **To unplug the air plug, pull on the plastic air plug at the base of the tube, not the tube itself.**
- **ONLY use the AC adapter, arm cuff, batteries and accessories specified for this monitor. Use of unsupported AC adapters, arm cuffs and batteries may damage and/or may be hazardous to this monitor.**
- **ONLY use the approved arm cuff for this monitor. Use of other arm cuffs may result in incorrect readings.**
- **Inflating to a higher pressure than necessary may result in bruising of the arm where the cuff is applied. NOTE: refer to “If your systolic pressure is more than 210 mmHg” in section 3 of this instruction manual for additional information.**



## **Data Transmission**

- **DO NOT** replace batteries or unplug the AC adapter while your readings are being transferred to your smart device. This may result in incorrect operation of this monitor and failure to transfer your blood pressure data.

## **AC Adapter (optional accessory) Handling and Usage**

- **Fully** insert the AC adapter into the outlet.
- **When unplugging the AC adapter from the outlet, be sure to safely pull from the AC adapter. DO NOT pull from the AC adapter cable.**
- **When handling the AC adapter cable:**
  - DO NOT** damage it.
  - DO NOT** break it.
  - DO NOT** tamper with it.
  - DO NOT** forcibly bend or pull it.
  - DO NOT** twist it.
  - DO NOT** use it if it is gathered in a bundle.
  - DO NOT** pinch it.
  - DO NOT** place it under heavy objects.
- **Wipe any dust off of the AC adapter.**
- **Unplug the AC adapter when not in use.**
- **Unplug the AC adapter before cleaning this monitor.**

## **Battery Handling and Usage**

- **DO NOT** insert batteries with their polarities incorrectly aligned.
  - **ONLY** use 4 “AA” alkaline or manganese batteries with this monitor. **DO NOT** use other types of batteries. **DO NOT** use new and used batteries together. **DO NOT** use different brands of batteries together.
  - **Remove** batteries if this monitor will not be used for a long period of time.
  - If battery fluid should get in your eyes, immediately rinse with plenty of clean water. Consult with your physician immediately.
  - If battery fluid should get on your skin, wash your skin immediately with plenty of clean, lukewarm water. If irritation, injury or pain persists, consult with your physician.
  - **DO NOT** use batteries after their expiration date.
  - **Periodically** check batteries to ensure they are in good working condition.
-

# 1. Know Your Monitor

## 1.1 Contents/Product Includes

Monitor, 4 “AA” batteries, Wide-Range D-Ring Cuff, instruction manual, quick start guide

## 1.2 Monitor and Arm Cuff

### Front of the monitor

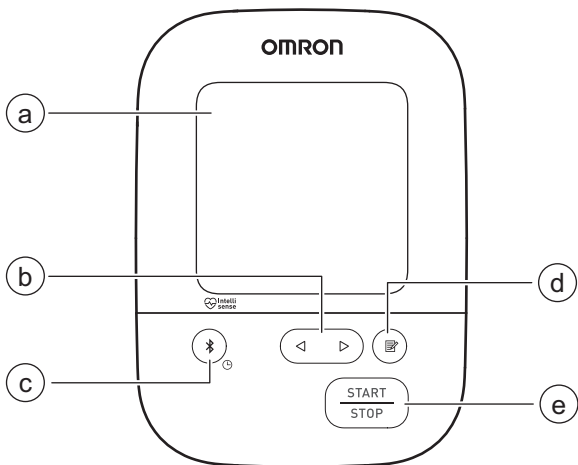

- (a) Display
- (b) [Forward/Backward] buttons
- (c) [Connection] button  
(Date/Time)
- (d) [Memory] button
- (e) [START/STOP] button

## Left side, back and bottom of the monitor

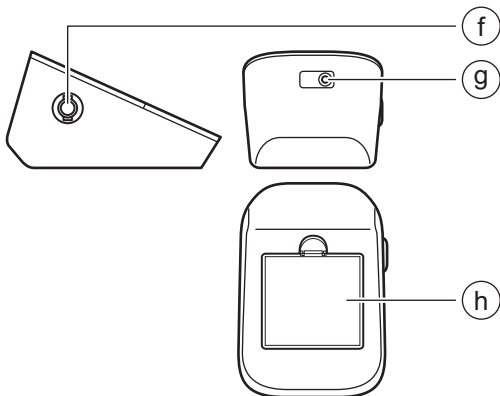

- ⓕ Air jack
- ⓖ AC adapter jack  
(for optional AC adapter)
- ⓗ Battery compartment

## Arm cuff





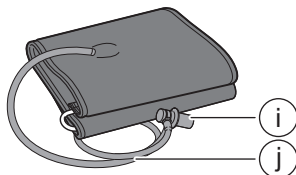

(Upper arm circumference: 9" - 17" (22 - 42 cm))

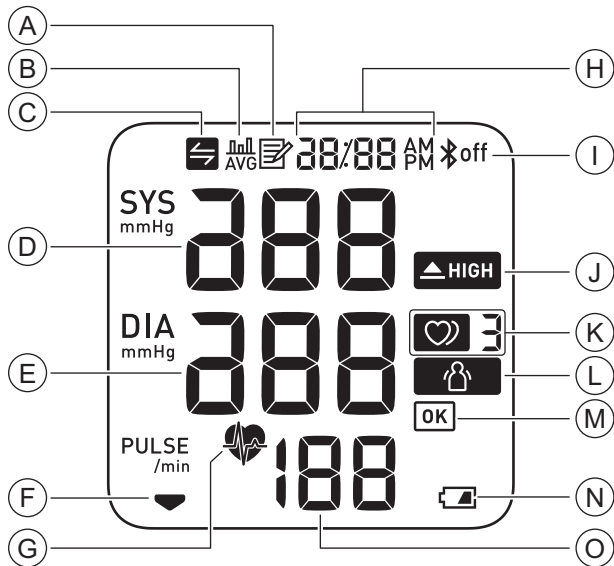





- ⓔ Air plug
- ⓙ Air tube









### 1.3 Display and Symbols



Ⓐ		<b>Memory symbol</b> Appears when viewing readings stored in the memory.
Ⓑ		<b>Average value symbol</b> Flashes when viewing the average of the latest 2 or 3 readings taken within the most recent 10 minute timeframe.
Ⓒ		<b>Sync symbol</b> Flashes/appears when your data needs to be transferred because the stored memory is either almost, or completely full. Once you pair your monitor with your smart device, transfer your readings immediately before the monitor deletes the oldest reading. Up to 60 readings can be stored in the internal memory of your monitor.
Ⓓ <b>Systolic blood pressure reading</b>		
Ⓔ <b>Diastolic blood pressure reading</b>		
Ⓕ		<b>Deflation symbol</b> Appears during cuff deflation.
Ⓖ		<b>Heartbeat symbol</b> Flashes while taking a measurement.
Ⓗ <b>Date / Time display</b>		
Ⓘ		<b>Bluetooth ON symbol</b> Appears when your readings are being transferred.
		<b>Bluetooth OFF symbol</b> Appears when Bluetooth is disabled.

<p>ⓐ</p>		<p><b>High symbol</b> Appears if your systolic blood pressure is <math>\geq 130</math> mmHg or the diastolic blood pressure is <math>\geq 80</math> mmHg. Refer to sub-section 1.4 for more information.</p>
<p>ⓑ</p>	<p>             or   </p>	<p><b>Irregular heartbeat symbol</b> Appears when irregular rhythm is detected 2 or more times during a measurement. The symbol with the number appears as below:</p> <p>Irregular heartbeat is detected 2 times:  2            Irregular heartbeat is detected 3 times or more:  3</p> <p>An irregular heartbeat rhythm is defined as a rhythm that is 25 % less or 25 % more than the average rhythm detected while your monitor is measuring blood pressure.</p> <div style="text-align: center;">  <p>Irregular Heartbeat      Short      Long</p> <p>Normal Heartbeat</p> </div> <p>Irregular heartbeat symbol may be displayed when the monitor detects arm movements. Refer to section 7 for more information.</p> <p><b>If it continues to appear, we recommend you to consult with and follow the directions of your physician.</b></p>
<p>ⓒ</p>		<p><b>Movement error symbol</b> Appears with your reading when your body is moving during a measurement. If it appears, remove the arm cuff and wait for 2 to 3 minutes. Then, reapply the cuff, remain still and take another measurement.</p>



		<p><b>OK symbol</b> Flashes when your monitor is connected to your smart device or readings are transferred successfully.</p>
		<p><b>Low battery symbol</b> Flashes when batteries are low.</p>
		<p><b>Depleted battery symbol</b> Appears when batteries are depleted.</p>
	<p><b>Pulse display / Memory number</b> Pulse rate appears after the measurement. When pressing the  button, the memory number will also appear for approximately 1.5 seconds before the pulse rate shows again on the display.</p>	

## 1.4 Classification of BP (Blood Pressure)

ACC/AHA 2017 Hypertension guidelines define categories of BP in adults as below.

### Categories of BP in Adults\*

BP Category	Systolic BP	Diastolic BP
<b>Normal</b>	< 120 mmHg	and < 80 mmHg
<b>Elevated</b>	120 - 129 mmHg	and < 80 mmHg
<b>Hypertension</b>		
Stage 1	130 - 139 mmHg	or 80 - 89 mmHg
Stage 2	≥ 140 mmHg	or ≥ 90 mmHg

\* Individuals with Systolic BP and Diastolic BP in 2 categories should be designated to the higher BP category.

BP indicates blood pressure (based on an average of ≥ 2 careful readings obtained on ≥ 2 occasions).

Source: ACC/AHA 2017 High Blood Pressure Clinical Practice Guideline

### **⚠ Warning**

- NEVER diagnose or treat yourself based on your readings. ALWAYS consult with your physician.

## 2. Preparation

### 2.1 Installing Batteries

1. Push down on the hook of the battery cover and pull upward.

2. Insert 4 “AA” batteries as indicated in the battery compartment.

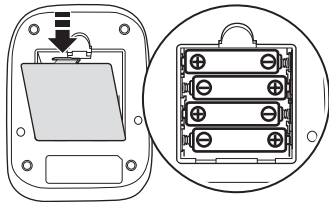

3. Close the battery cover.

As soon as batteries are correctly installed, the year flashes on the display.

Refer to sub-section 2.2 to set the date and time manually, or refer to sub-section 4.1 to pair your monitor to set the date and time automatically.



### Note

- When the “” symbol flashes on the display, it is recommended you replace batteries.
- To replace batteries, turn your monitor off and remove all batteries. Then replace with 4 new batteries at the same time.
- Replacing batteries will not delete previous readings.
- The supplied batteries may have a shorter life span than new batteries.
- Disposal of used batteries should be carried out in accordance with local regulations.

## 2.2 Setting the Date and Time



### Note

- Set your monitor to the correct date and time before taking a measurement for the first time.
- The date and time will automatically be set when the monitor is paired with the compatible OMRON app. Refer to sub-section 4.1.
- As soon as batteries are correctly installed, the year flashes on the display of your monitor.

---

1. If nothing is displayed, press the  button to display the year. If the year is already displayed, skip this step.

---

2. Press the  or  button to adjust the year.

Press and hold the  button to quickly advance the years.

Press and hold the  button to quickly go backwards through the years.

---

3. Press the  button to confirm the year, then the month will flash. Repeat the same steps to adjust the month, day, hour, and minute.

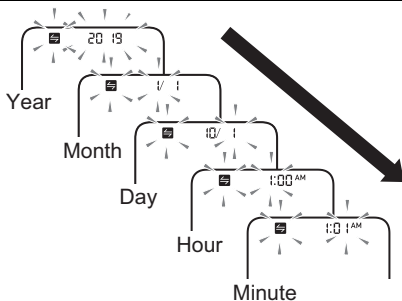

---

#### 4. Press the button to store the setting.

Your monitor automatically turns off 3 seconds after the minutes have been set in this sequence.

#### Note

- If you need to reset the date and time, replace batteries or press the  button, then set the date and time as shown in above steps.
- If the date and time are not set, “ - : - - ” flashes during or after measurement.

### 2.3 Blood Pressure Measurement Tips

To help ensure an accurate reading, follow these directions:

- Stress raises blood pressure. Avoid taking measurements during stressful times.
- Measurements should be taken in a quiet place.
- It is important to take measurements at the same times each day. Taking measurements in the morning and in the evening is recommended.
- Remember to have a record of your blood pressure and pulse readings for your physician. A single measurement does not provide an accurate indication of your true blood pressure. You need to take and record several readings over a period of time.

---

#### Caution

- Avoid bathing, drinking alcohol or caffeine, smoking, exercising and eating for at least 30 minutes before taking a measurement.
  - Rest for at least 5 minutes before taking a measurement.
-

## 2.4 Applying the Arm Cuff

### Note

- The following steps are for applying the arm cuff to your left arm. When you take a measurement on your right arm, follow the cuff wrap instructions for a right arm use mentioned under “To take a measurement on your right arm” located at the end of this sub-section.
- The blood pressure can differ between the right arm and the left arm, and the measured blood pressure readings can be different. OMRON recommends to always use the same arm for measurement. If the readings between both arms differ substantially, check with your physician to determine as to which arm to use for your measurements.

### ⚠ Caution

- Remove tight-fitting or thick clothing from your arm while taking a measurement.

1. Plug the arm cuff into your monitor by inserting the air plug into the air jack securely until it clicks.

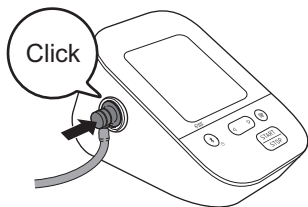

2. Place your hand through the cuff loop. Pull the cuff until it reaches your upper left arm.



**Note**

- The bottom edge of the arm cuff should be 0.5 inch (1 to 2 cm) above the inside elbow. The air tube is on the inside of your arm and aligned with your middle finger.

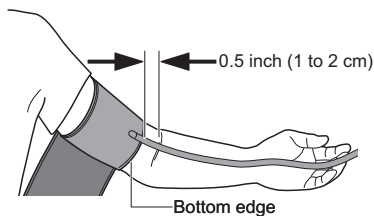

3. Make sure that the air tube is positioned on the inside of your arm and wrap the cuff securely, so it can not move around your arm.

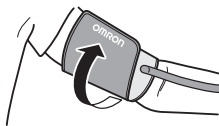
**To take a measurement on your right arm**

When you take a measurement on your right arm, the air tube should run along the side of your elbow, along the bottom of your arm. Be careful not to rest your arm on the air tube.



## 2.5 Sitting Correctly

To take a measurement, you need to be relaxed and comfortably seated in a room with a comfortable temperature. Place your arm on the table.

- Sit in a comfortable chair with your back and arm supported.
- Keep your feet flat and your legs uncrossed.
- The arm cuff should be placed on your arm at the same level as your heart, with the arm resting comfortably on a table.





## 3. Using Your Monitor without a Smart Device

### 3.1 Taking a Measurement

You can use your monitor without pairing to a smart device. To pair your monitor with a smart device, refer to sub-section 4.1.

#### Note

- To stop the measurement, press the [START/STOP] button once to deflate the arm cuff.

#### Caution

- DO NOT use this monitor with other medical electrical (ME) equipment simultaneously. This may result in incorrect operation of the monitor and/or cause an inaccurate reading.
- Remain still and DO NOT talk while taking a measurement.

- 
1. Press the [START/STOP] button.  
All symbols appear on the display before starting the measurement.

- 
2. Remain still and do not talk until the entire measurement process is complete.

The “” symbol flashes at every heartbeat.

After your monitor has detected your blood pressure and pulse rate, the cuff automatically deflates. Your blood pressure and pulse rate are displayed.

If either the systolic or the diastolic reading is high (refer to sub-section 1.3), the “” symbol appears.

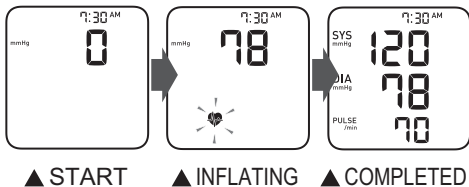

- 
3. Press the [START/STOP] button to turn your monitor off.

**Note**

- Your monitor automatically turns off after 2 minutes.
- Wait 2 - 3 minutes between measurements. The wait time allows the arteries to decompress and return to their pre-measurement state. You may need to increase the wait time depending on your individual physiological characteristics.

## ■ Using the Guest Mode

The guest mode can be used to take a single measurement for another user.

### Note

- No readings are stored in the memory.

1. Press and hold the [START/STOP] button for more than 2 seconds.

The date/time display will disappear.



2. Release the [START/STOP] button when the date/time display turns off.

The arm cuff automatically starts to inflate.

## ■ If your systolic pressure is more than 210 mmHg

If your systolic pressure is more than 210 mmHg, take a measurement manually.

After the arm cuff starts to inflate, press and hold the [START/STOP] button until the monitor inflates 30 to 40 mmHg higher than your expected systolic pressure.

### Note

- Do not inflate above 299 mmHg.

### ⚠ Caution

- Inflating to a higher pressure than necessary may result in bruising of the arm where the cuff is applied.

## 4. Using Your Monitor with a Smart Device

### 4.1 Pairing Your Monitor with a Smart Device

The date and time on your monitor will automatically be set when you pair your monitor with your smart device.

Review the list of compatible smart devices at [OmronHealthcare.com/connect](http://OmronHealthcare.com/connect)

1. Enable Bluetooth on your smart device.
2. Scan the code below with your smart device camera or visit [OmronHealthcare.com/app](http://OmronHealthcare.com/app) to find the OMRON compatible app for this product.



3. Download and install the compatible OMRON app onto your smart device.  
If you already have the compatible OMRON app and have created your account, open the app and add your new monitor.
4. Open the app and follow the pairing instructions shown on your smart device.

---

5. Confirm that your monitor is connected successfully.

When your monitor is connected successfully to your smart device, the OK symbol appears.

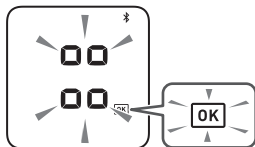

---

6. Press the [START/STOP] button to turn your monitor off.

**Note**

- If the “Err” symbol appears, follow the instructions in the app.
- Your monitor automatically turns off after 2 minutes.
- Be aware that OMRON will not be responsible for the loss of data and/or information in the app.
- Only compatible OMRON apps should be used with this monitor to help ensure correct data transfer.

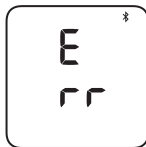

## 4.2 Taking a Measurement

Refer to sub-section 3.1 to start a measurement. Open the app on your smart device and follow the instructions.

**Note**

- Make sure that your monitor is within 16 ft. (5m) of your smart device.

### ■ Transferring Data Automatically/Manually

- When Bluetooth is enabled, the readings will be transferred to your smart device within 1 hour after taking a measurement.
- To transfer the readings manually, press the  button.

### 4.3 Disabling/Enabling Bluetooth

#### **Warning**

- This product emits radio frequencies (RF) in the 2.4 GHz band. DO NOT use this product in locations where RF is restricted, such as on an aircraft or in hospitals. Turn off the Bluetooth feature in this monitor and remove batteries when in RF restricted areas. For further information on potential restrictions refer to documentation on the Bluetooth usage by the FCC.

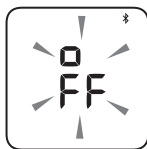

Bluetooth is enabled as default.

1. When your monitor is off, press and hold the  button for more than 10 seconds.  
“oFF” flashes 3 times.



2. Press the [START/STOP] button to turn your monitor off.

#### **Note**

- To enable the Bluetooth, press and hold the  button for more than 2 seconds. “on” appears on the display.
- Your monitor automatically turns off 2 minutes after the completion.
- When Bluetooth is disabled, the “ off ” symbol appears.

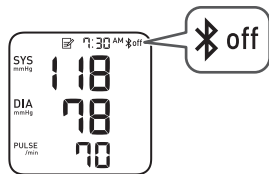

## 5. Using Memory Function

Your monitor automatically stores up to 60 readings.

### Note

- This monitor can be used by multiple users. When you use memory function with other users, track (or manage) your own readings appropriately.

### 5.1 Viewing the Readings Stored in Memory

1. Press the  button.

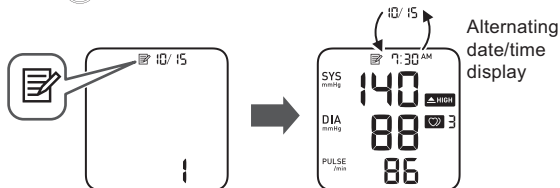

The Memory number appears for 1.5 seconds before the pulse rate is displayed. The most recent reading stored in the memory will be numbered as “1”.

### Note

- If the reading is high (refer to sub-section 1.3), the “ HIGH” symbol appears.
- If there are no readings stored in the memory, the screen to the right is displayed.
- If the memory is full, new readings will replace the old readings, starting with the oldest reading.

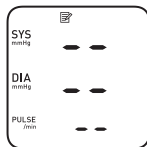

- 
2. Press the ◀ or ▶ button repeatedly to scroll through the previous readings stored in the memory.

◀ : To view the older readings

▶ : To view the more recent readings

## 5.2 Viewing the Average Reading

Your monitor can calculate an average reading based on the latest 2 or 3 readings taken within the most recent 10 minute timeframe.

### Note

- Set your monitor to the correct date and time before taking a measurement to view the average readings.

- 
1. When your monitor is off, press and hold the

 button for more than 2 seconds.

The “” symbol flashes.

### Note

- If there are only 2 readings in the memory for that period, the average will be based on these 2 readings.
- If the average reading is high (refer to sub-section 1.3), the “ HIGH” symbol appears.





## 6. Other Settings

### 6.1 Deleting All Readings Stored in Memory

---

1. Press the  button.

After a memory number appears, the latest reading will appear.

---

2. While holding the  button down, press and hold the [START/STOP] button for more than 3 seconds.  
The display to the right flashes.

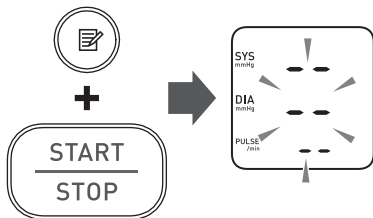

3. While holding the  button down again, press and hold the [START/STOP] button for more than 3 seconds.  
The display stops flashing, then all readings are deleted.

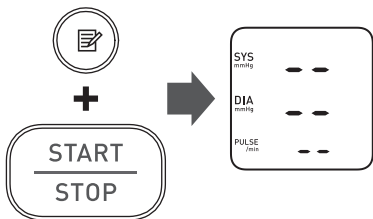

4. Press the [START/STOP] button to turn your monitor off.

#### Note

- All readings will be deleted. You cannot partially delete the readings stored in the memory.
- Your monitor automatically turns off after 2 minutes.

## 6.2 Restoring Your Monitor to the Default Settings

To delete all the information stored in your monitor, follow the instructions below. Make sure that your monitor is turned off.

1. While holding the



Ⓜ button down, press and hold the [START/STOP] button for more than 3 seconds.

The display to the right flashes.

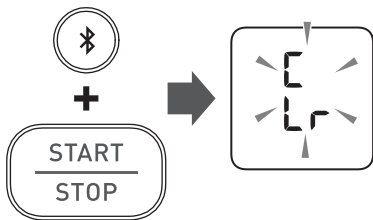

2. While holding the



Ⓜ button down again, press and hold the [START/STOP] button for more than 3 seconds.

The display stops flashing, then your monitor is restored to the default settings.

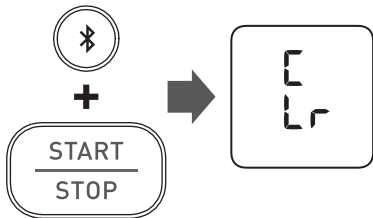

3. Press the [START/STOP] button to turn your monitor off.

### Note







- After the completion, the year flashes on the display. Refer to sub-section 2.2 to set the date and time manually, or refer to sub-section 4.1 to pair your monitor to set the date and time automatically.
- Reverting to the default setting of your monitor does not delete the information in the app.





## 7. Error Messages and Troubleshooting

If any of the below problems occur during measurement, check to make sure that no other electrical device is within 12 inches (30 cm). If the problem persists, refer to the table below.

Display/Problem	Possible Cause	Solution
<b>E1</b> appears or the arm cuff does not inflate.	The [START/STOP] button was pressed while the arm cuff is not applied.	Press the [START/STOP] button again to turn the monitor off. After inserting the air plug securely and applying the arm cuff correctly, press the [START/STOP] button.
	Air plug is not completely plugged into the monitor.	Insert the air plug securely. Refer to sub-section 2.4.
	The arm cuff is not applied correctly.	Apply the arm cuff correctly, then take another measurement. Refer to sub-section 2.4.
	Air is leaking from the arm cuff.	Replace the arm cuff with a new one. Refer to section 9.

Display/Problem	Possible Cause	Solution
<p data-bbox="135 323 218 387"><b>E2</b></p> <p data-bbox="47 397 306 548">appears or a measurement cannot be complete after the arm cuff inflates.</p>	<p data-bbox="325 263 643 387">You move or talk during a measurement and the arm cuff does not inflate sufficiently.</p>	<p data-bbox="665 166 988 485">Remain still and do not talk during a measurement. If “E2” appears repeatedly, inflate the arm cuff manually until the systolic pressure is 30 to 40 mmHg above your previous readings. Refer to sub-section 3.1.</p>
	<p data-bbox="325 549 643 673">The systolic pressure is above 210 mmHg and a measurement cannot be taken.</p>	<p data-bbox="665 520 988 704">Inflate the arm cuff manually until the systolic pressure is 30 to 40 mmHg above your previous readings. Refer to sub-section 3.1.</p>
<p data-bbox="135 803 218 866"><b>E3</b></p> <p data-bbox="122 877 232 901">appears</p>	<p data-bbox="325 805 643 897">The arm cuff is inflated exceeding the maximum allowable pressure.</p>	<p data-bbox="665 739 988 962">Do not touch the arm cuff and/or bend the air tube while taking a measurement. If inflating the arm cuff manually, refer to the end of sub-section 3.1.</p>
<p data-bbox="135 1009 218 1072"><b>E4</b></p> <p data-bbox="122 1083 232 1107">appears</p>	<p data-bbox="325 994 636 1118">You move or talk during a measurement. Vibrations disrupt a measurement.</p>	<p data-bbox="665 1009 967 1100">Remain still and do not talk during a measurement.</p>

Display/Problem	Possible Cause	Solution
 appears	The pulse rate is not detected correctly.	Apply the arm cuff correctly, then take another measurement. Refer to sub-section 2.4. Remain still and sit correctly during a measurement.  If the “  ” symbol continues to appear, we recommend you to consult with your physician.
 appears		
 does not flash during a measurement		
 appears	The monitor has malfunctioned.	Press the [START/STOP] button again. If “Er” still appears, contact customer service. Refer to section 12.
 appears	The monitor cannot connect to a smart device or transmit data correctly.	Follow the instructions shown in the app. If the “Err” symbol still appears after checking the app, contact customer service. Refer to section 12.

Display/Problem	Possible Cause	Solution
	<p>The monitor is waiting for pairing with the smart device.</p>	<p>Refer to sub-section 4.1 for pairing your monitor with your smart device, or press the [START/STOP] button to cancel pairing and turn your monitor off.</p>
	<p>The monitor is ready to transfer your readings to the smart device.</p>	<p>Open the app to transfer your readings.</p>
	<p>There are more than 48 readings in memory to be transferred.</p>	<p>Pair or transfer your readings to the app so you can keep them in memory in the app, and this error symbol disappears.</p>
	<p>The date and time is not set.</p>	
	<p>Batteries are low.</p>	<p>Replacing all 4 batteries with new ones is recommended. Refer to sub-section 2.1.</p>

Display/Problem	Possible Cause	Solution
 appears or the monitor is turned off unexpectedly during a measurement.	Batteries are depleted.	Immediately replace all 4 batteries with new ones. Refer to sub-section 2.1.
Nothing appears on the display of the monitor.	Batteries are depleted.	
	Battery polarities are not properly aligned.	Check the battery installation for proper placement. Refer to sub-section 2.1.
Readings appear too high or too low.	Blood pressure varies constantly. Many factors including stress, time of day, and/or how you apply the arm cuff, may affect your blood pressure. Review sub-sections 2.3 - 2.5 and section 3.	
Any other communication issue occurs.	Follow the instructions shown in the smart device, or visit the “Help” section in the app for further help. If the problem still persists, contact customer service. Refer to section 12.	
Any other problems occur.	Press the [START/STOP] button to turn the monitor off, then press it again to take a measurement. If the problem continues, remove all batteries and wait for 30 seconds. Then re-install batteries. If the problem still persists, contact customer service. Refer to section 12.	

## 8. Maintenance

### 8.1 Maintenance

To protect your monitor from damage, follow the directions below:

- Changes or modifications not approved by the manufacturer will void the user warranty.

#### Caution

- DO NOT disassemble or attempt to repair this monitor or other components. This may cause an inaccurate reading.

### 8.2 Storage

Store your monitor and other components in a clean, safe location.

1. Remove the arm cuff from the monitor.

#### Caution

- To unplug the air plug, pull on the plastic air plug at the base of the tube, not the tube itself.

2. Gently fold the air tube into the arm cuff.

#### Note

- Do not bend or crease the air tube excessively.

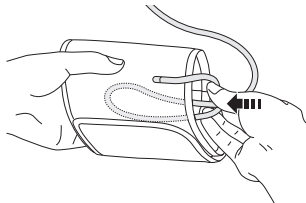



Do not store your monitor and other components:

- If your monitor and other components are wet.
- In locations exposed to extreme temperatures, humidity, direct sunlight, dust or corrosive vapors such as bleach.
- In locations exposed to vibrations or shocks.

### **8.3 Cleaning**

- Do not use any abrasive or volatile cleaners.
- Use a soft dry cloth or a soft cloth moistened with mild (neutral) detergent to clean your monitor and arm cuff and then wipe them with a dry cloth.
- Do not wash or immerse your monitor and arm cuff or other components in water.
- Do not use gasoline, thinners or similar solvents to clean your monitor and arm cuff or other components.

### **8.4 Disposal**

Dispose of your monitor, other components and optional accessories according to applicable local regulations.

Unlawful disposal may cause environmental pollution.

## 9. Optional Accessories

### Small D-Ring Cuff

Arm circumference  
7" - 9" (17 - 22 cm)



Model:

HEM-CS24-B REF HEM-CS24-BZ

### Wide-Range D-Ring Cuff

Arm circumference  
9" - 17" (22 - 42 cm)



Model:

HEM-RML31-B REF HEM-RML31-BZ

- Same as the arm cuff provided with the product.

### Note

- Do not throw the air plug away. The air plug can be applicable to the optional cuff.

### AC Adapter

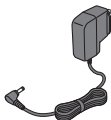

Model: HEM-ADPTW5

For further information, visit our website at [OmronHealthcare.com](http://OmronHealthcare.com)

## Using the AC Adapter (optional accessory)

### Note

- Make sure not to place your monitor in a location where it is difficult to plug and unplug the AC adapter.
- We recommend keeping batteries in your monitor at all times, even if you choose to use the AC adapter. If only the AC adapter is used without keeping batteries in your monitor, you may need to reset the date and time each time you unplug and plug back the AC adapter. The readings will not be deleted.

1. Insert the AC adapter plug into the AC adapter jack on the rear side of your monitor.

2. Plug the AC adapter into an electrical outlet.

To unplug the AC adapter, unplug the AC adapter from the electrical outlet and then remove the AC adapter plug from the monitor.

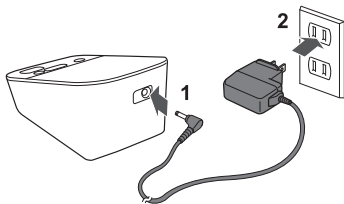

### **⚠ Caution**

- ONLY use the AC adapter, arm cuff, batteries and accessories specified for this monitor. Use of unsupported AC adapters, arm cuffs and batteries may damage and/or may be hazardous to this monitor.

## 10. Specifications

Model	BP7250 <small>REF</small> HEM-7150T-Z
Display	LCD digital display
Cuff pressure range	0 to 299 mmHg
Blood pressure measurement range	SYS: 60 to 260 mmHg DIA: 40 to 215 mmHg
Pulse measurement range	40 to 180 beats / min.
Accuracy	Pressure: $\pm 3$ mmHg Pulse: $\pm 5$ % of display reading
Inflation	Automatic by electric pump
Deflation	Automatic pressure release valve
Measurement method	Oscillometric method
Transmission method	<b>Bluetooth®</b> Low Energy
Wireless communication	Frequency range: 2.4 GHz (2400 - 2483.5 MHz) Modulation: GFSK Effective radiated power: < 20 dBm
Operation mode	Continuous operation
IP classification	Monitor: IP20 Optional AC adapter: IP21
Rating	DC6 V 4.0 W
Power source	4 "AA" batteries 1.5 V or optional AC adapter (INPUT AC100 - 240 V 50 - 60 Hz 0.12 - 0.065 A)
Battery life	Approximately 1000 measurements (using new alkaline batteries)

Durable period (Service life)	Monitor: 5 years Arm cuff: 5 years Optional AC adapter: 5 years
Operating conditions	+50 °F to +104 °F (+10 °C to +40 °C) / 15 to 90 % RH (non-condensing) / 800 to 1060 hPa
Storage / Transport conditions	-4 °F to +140 °F (-20 °C to +60 °C) / 10 to 90 % RH (non-condensing)
Weight	Monitor: Approximately 12.0 oz. (340 g) not including batteries Arm cuff: Approximately 6 oz. (170 g)
Dimensions	Monitor: Approximately 4.2" (w) × 3.4" (h) × 6.0" (l) (105 mm × 85 mm × 152 mm) Arm cuff: Approximately 5.7" × 23.4" (air tube: 29.5") (145 mm × 594 mm (air tube: 750 mm))
Cuff circumference applicable to the monitor	7" to 17" (17 to 42 cm) (included arm cuff: 9" to 17" (220 to 420 mm))
Memory	Stores up to 60 readings
Contents	Monitor, Wide-Range D-Ring Cuff, 4 "AA" batteries, instruction manual, quick start guide
Protection against electric shock	Internally powered ME equipment (When using only batteries) Class II ME equipment (Optional AC adapter)
Applied part	Type BF (arm cuff)

### Note

- These specifications are subject to change without notice.
- This monitor complies with the requirements of ISO 81060-2:2013. In the clinical validation study, K5 was used on 85 subjects for determination of diastolic blood pressure.
- This monitor has not been validated for use on pregnant patients.



- IP classification is degrees of protection provided by enclosures in accordance with IEC 60529. This monitor and optional AC adapter are protected against solid foreign objects of 0.5 inch (12.5 mm) diameter and greater such as a finger. The optional AC adapter is protected against vertically falling water drops which may cause issues during a normal operation.

#### **About a wireless communication interference**

This product operates in an unlicensed ISM band at 2.4 GHz. In the event this product is used near other wireless devices such as microwave and wireless LAN, which operate on the same frequency band as this product, there is a possibility that interference may occur.

If interference occurs, stop the operation of the other devices or relocate this product away from other wireless devices before attempting to use it.

#### **Pictogram on the Product**

 <p>● or ○ ART.</p>	<p>Types of marks used to indicate the correct positioning of the artery for the upper arm</p>
	<p>Identifies the type of cuff that is compatible with the blood pressure monitor</p>

## 11. FCC Statement

### FCC CAUTION

Changes or modifications not expressly approved by the party responsible for compliance could void the user's authority to operate the equipment.

This device complies with part 15 of the FCC Rules. Operation is subject to the following two conditions: (1) This device may not cause harmful interference, and (2) this device must accept any interference received, including interference that may cause undesired operation.

### Note

- This equipment has been tested and found to comply with the limits for a Class B digital device, pursuant to part 15 of the FCC Rules. These limits are designed to provide reasonable protection against harmful interference in a residential installation. This equipment generates, uses and can radiate radio frequency energy and, if not installed and used in accordance with the instructions, may cause harmful interference to radio communications. However, there is no guarantee that interference will not occur in a particular installation. If this equipment does cause harmful interference to radio or television reception, which can be determined by turning the equipment off and on, the user is encouraged to try to correct the interference by one or more of the following measures:
  - Reorient or relocate the receiving antenna.
  - Increase the separation between the equipment and receiver.
  - Connect the equipment into an outlet on a circuit different from that to which the receiver is connected.
  - Consult the dealer or an experienced radio/TV technician for help.

This transmitter must not be co-located or operated in conjunction with any other antenna or transmitter.

This equipment complies with FCC radiation exposure limits set forth for an uncontrolled environment and meets the FCC radio frequency (RF) Exposure Guidelines. This equipment has very low levels of RF energy that are deemed to comply without testing of specific absorption ratio (SAR).



## 12. Limited Warranty

Your BP7250 Blood Pressure Monitor, excluding the arm cuff and batteries is warranted to be free from defects in materials and workmanship appearing within 2 years from the date of purchase, when used in accordance with the instructions provided with the monitor. The arm cuff is warranted to be free from defects in materials and workmanship appearing within 1 year from the date of purchase when the monitor is used in accordance with the instructions provided with the monitor. The above warranty extends only to the original retail purchaser, and only to products purchased from an Omron authorized seller who is subject to and follows Omron's quality control standards, unless otherwise prohibited by law. We will, at our option, replace without charge any monitor or arm cuff covered by the above warranty. Replacement is our only responsibility and your only remedy under the above warranty.

To obtain warranty service contact Customer Service by calling **1-800-634-4350** for the address of the inspection center and the return shipping and handling fee that may apply.

Enclose the original printed receipt. Include a letter, with your name, address, phone number, and description of the specific problem. Pack the product carefully to prevent damage in transit. Because of possible loss in transit, we recommend insuring the product with return receipt requested.

**THE FOREGOING IS THE SOLE WARRANTY PROVIDED BY OMRON IN CONNECTION WITH THIS PRODUCT, AND OMRON HEREBY DISCLAIMS ANY OTHER WARRANTIES, EXPRESS OR IMPLIED, INCLUDING IMPLIED WARRANTIES OF MERCHANTABILITY AND FITNESS FOR A PARTICULAR PURPOSE. IMPLIED WARRANTIES AND OTHER TERMS THAT MAY BE IMPOSED BY LAW, IF ANY, ARE LIMITED IN DURATION TO THE PERIOD OF THE ABOVE EXPRESS WARRANTY.**

**SOME STATES DO NOT ALLOW LIMITATIONS ON HOW LONG AN IMPLIED WARRANTY LASTS, SO THE ABOVE LIMITATION MAY NOT APPLY TO YOU.**

**OMRON SHALL NOT BE LIABLE FOR LOSS OF USE OR ANY OTHER SPECIAL, INCIDENTAL, CONSEQUENTIAL OR INDIRECT COSTS, EXPENSES OR DAMAGES.**

**SOME STATES DO NOT ALLOW THE EXCLUSION OR LIMITATION OF INCIDENTAL OR CONSEQUENTIAL DAMAGES, SO THE ABOVE LIMITATION OR EXCLUSION MAY NOT APPLY TO YOU.**

This warranty provides you with specific legal rights, and you may have other rights that vary by jurisdiction. Because of special local requirements, some of the above limitations and exclusions may not apply to you.

**FOR CUSTOMER SERVICE**

Visit our web site at:

[OmronHealthcare.com](http://OmronHealthcare.com)

Call toll free:

1-800-634-4350

## 13. Guidance and Manufacturer's Declaration

OMRON Battery-operated / AC Adapter-operated Blood Pressure Monitor  
Information for Accompanying Documents in the Scope of  
IEC60601-1-2:2014

### **Important information regarding Electromagnetic Compatibility (EMC)**

BP7250 conforms to IEC60601-1-2:2014 Electromagnetic Compatibility (EMC) standard.

Further documentation in accordance with this EMC standard is available at [OmronHealthcare.com/emc](http://OmronHealthcare.com/emc). Refer to the EMC information for BP7250 on the website.

The **Bluetooth**<sup>®</sup> word mark and logos are registered trademarks owned by Bluetooth SIG, Inc. and any use of such marks by OMRON HEALTHCARE Co., Ltd. is under license. Other trademarks and trade names are those of their respective owners.



OMRON HEALTHCARE Co., Ltd  
53, Kunotsubo, Terado-cho, Muko, Kyoto, 617-0002 JAPAN

Distributed by:  
OMRON HEALTHCARE, INC.  
2895 Greenspoint Pkwy. Hoffman Estates, IL 60169 USA

OmronHealthcare.com  
© 2021 OMRON HEALTHCARE, INC.

Made in Vietnam