

Rogue XP / Clik / Little Wave XP Drum Brake

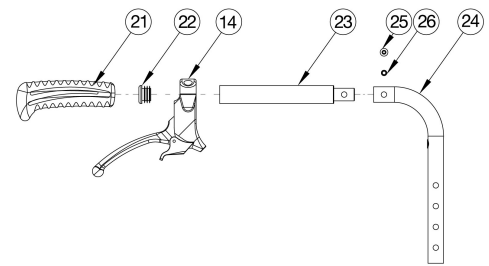

Cable (Item 17) Size for Backrest				
Backrest Height	Fixed Height with Standard Push Handles	Height Adjustable with Standard Push Handles		Double Stroller Handle
		Ex. Short & Short	Medium & Tall	
9"	4XS		3XS	XS
10"	4XS		3XS	XS
11"	3XS		3XS	XS
12"	3XS		3XS	SHT
13"	3XS		3XS	SHT
14"	3XS		3XS	SHT
15"	2XS			SHT
16"	2XS			MED
17"	2XS			MED
18"	2XS			MED

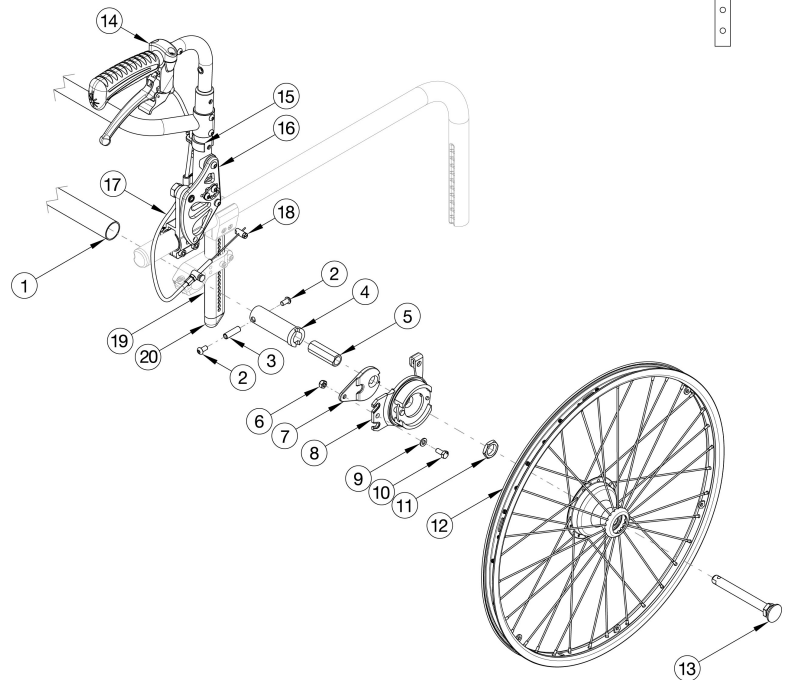

For a complete retrofit, quote a drum brake retrofit kit (qty 1), backtube / stroller handle kit (qty 2), drum brake cable kit (qty 2) and new rear towers (qty 2). Replacement Camber Mount Towers may be quoted, but must be ordered through Customer Service. If chair includes both push handles and rigidizer mounted handles, Drum Brake handles are installed on the rigidizer mounted handles. Most Drum Brake Retrofit Kits contain two wheels, but do not contain rear tires or handdrims. If 24" Pneumatic w/ Airless Insert tires are needed, kits 116570 - 116574 contain Pneumatic w/ Airless Insert tires and the inserts but no handdrims. For item number 1, a new camber tube is required when changing the degree of camber by more than 2 degrees. See Rigid Camber Tube and Adapters parts manual page if needing a new camber tube.

Item Number	Part Number	Description	Quantity
2, 3, 4a, 5, 6, 7, 8a, 8b, 9, 10, 11, 12a, 13, 18	113225	Drum Brake Retrofit Kit 20" MAXX Spoke, 0° Camber	1
2, 3, 4b, 5, 6, 7, 8a, 8b, 9, 10, 11, 12a, 13, 18	113226	Drum Brake Retrofit Kit 20" MAXX Spoke, 2° Camber	1
2, 3, 4c, 5, 6, 7, 8a, 8b, 9, 10, 11, 12a, 13, 18	113227	Drum Brake Retrofit Kit 20" MAXX Spoke, 4° Camber	1

Item Number	Part Number	Description	Quantity
2, 3, 4d, 5, 6, 7, 8a, 8b, 9, 10, 11, 12a, 13, 18	113228	Drum Brake Retrofit Kit 20" MAXX Spoke, 6° Camber	1
2, 3, 4e, 5, 6, 7, 8a, 8b, 9, 10, 11, 12a, 13, 18	113229	Drum Brake Retrofit Kit 20" MAXX Spoke, 8° Camber	1
2, 3, 4a, 5, 6, 7, 8a, 8b, 9, 10, 11, 12b, 13, 18	113230	Drum Brake Retrofit Kit 22" MAXX Spoke, 0° Camber	1
2, 3, 4b, 5, 6, 7, 8a, 8b, 9, 10, 11, 12b, 13, 18	113231	Drum Brake Retrofit Kit 22" MAXX Spoke, 2° Camber	1
2, 3, 4c, 5, 6, 7, 8a, 8b, 9, 10, 11, 12b, 13, 18	113198	Drum Brake Retrofit Kit 22" MAXX Spoke, 4° Camber	1
2, 3, 4d, 5, 6, 7, 8a, 8b, 9, 10, 11, 12b, 13, 18	113232	Drum Brake Retrofit Kit 22" MAXX Spoke, 6° Camber	1
2, 3, 4e, 5, 6, 7, 8a, 8b, 9, 10, 11, 12b, 13, 18	113233	Drum Brake Retrofit Kit 22" MAXX Spoke, 8° Camber	1
2, 3, 4a, 5, 6, 7, 8a, 8b, 9, 10, 11, 12c, 13, 18	113234	Drum Brake Retrofit Kit 24" MAXX Spoke, 0° Camber	1
2, 3, 4b, 5, 6, 7, 8a, 8b, 9, 10, 11, 12c, 13, 18	113235	Drum Brake Retrofit Kit 24" MAXX Spoke, 2° Camber	1
2, 3, 4c, 5, 6, 7, 8a, 8b, 9, 10, 11, 12c, 13, 18	113236	Drum Brake Retrofit Kit 24" MAXX Spoke, 4° Camber	1
2, 3, 4d, 5, 6, 7, 8a, 8b, 9, 10, 11, 12c, 13, 18	113237	Drum Brake Retrofit Kit 24" MAXX Spoke, 6° Camber	1
2, 3, 4e, 5, 6, 7, 8a, 8b, 9, 10, 11, 12c, 13, 18	113238	Drum Brake Retrofit Kit 24" MAXX Spoke, 8° Camber	1
2, 3, 4a, 5, 6, 7, 8a, 8b, 9, 10, 11, 12c, 13, 18	118244	Drum Brake Retrofit Kit 24" MAXX Spoke, Pneumatic w/ Airless Insert Tire (Black), 0° Camber	1
2, 3, 4b, 5, 6, 7, 8a, 8b, 9, 10, 11, 12c, 13, 18	118240	Drum Brake Retrofit Kit 24" MAXX Spoke, Pneumatic w/ Airless Insert Tire (Black), 2° Camber	1
2, 3, 4c, 5, 6, 7, 8a, 8b, 9, 10, 11, 12c, 13, 18	118241	Drum Brake Retrofit Kit 24" MAXX Spoke, Pneumatic w/ Airless Insert Tire (Black), 4° Camber	1

Item Number	Part Number	Description	Quantity
2, 3, 4d, 5, 6, 7, 8a, 8b, 9, 10, 11, 12c, 13, 18	118242	Drum Brake Retrofit Kit 24" MAXX Spoke, Pneumatic w/ Airless Insert Tire (Black), 6° Camber	1
2, 3, 4e, 5, 6, 7, 8a, 8b, 9, 10, 11, 12c, 13, 18	118243	Drum Brake Retrofit Kit 24" MAXX Spoke, Pneumatic w/ Airless Insert Tire (Black), 8° Camber	1
21, 22, 23b, 24a, 25b, 26b	113221	Backtube w/ Push Handle Short with Backcane Extension, Drum Brake, Rigid <i>Used with extra short and short back height ranges with height adjustable backposts on Klik and Rogue XP. Used with short back height range with height adjustable backposts on Little Wave XP. Used with fixed height back posts on Klik, Rogue XP and Little Wave XP.</i>	2
21, 22, 23c, 24b, 25b, 26b	113222	Backtube w/ Push Handle Tall with Backcane Extension, Drum Brake, Rigid <i>Used with medium and tall back height ranges with height adjustable back posts on Klik and Rogue XP. Used with medium back height range with height adjustable backposts on Little Wave XP.</i>	2
21, 22, 23c, 24c, 26b, 26b	113223	Backtube w/ Push Handle Tall with Backcane Extension, Drum Brake, Rigid <i>Used with tall back height range with height adjustable back posts on Little Wave XP.</i>	2
21, 22, 23a, 24d, 25a, 26a	113197	Stroller Handle Back Post 8° Bend Short with Backcane Extension, Drum Brake <i>Used on chairs with 15" or greater rear seat height</i>	2
21, 22, 23a, 24d, 25a, 26a	113242	Stroller Handle Short Assembly with Backcane Extension, Drum Brake, Each, Rigid <i>Used on chairs with 15" or greater rear seat height. This kit also contains the stroller handle clamp assembly.</i>	2
21, 22, 23a, 24e, 25a, 26a	113224	Stroller Handle Back Post 8° Bend Tall with Backcane Extension, Drum Brake <i>Used on chairs with less than 15" rear seat height</i>	2
21, 22, 23a, 24e, 25a, 26a	113243	Stroller Handle Tall Assembly with Backcane Extension, Drum Brake, Each, Rigid <i>Used on chairs with less than 15" rear seat height. This kit also contains the stroller handle clamp assembly.</i>	2
14, 15, 16, 17a	113216	Drum Brake Cable Kit with Brake Lever, 4XS, Rigid	2
14, 15, 16, 17b	113217	Drum Brake Cable Kit with Brake Lever, 3XS, Rigid	2
14, 15, 16, 17c	113218	Drum Brake Cable Kit with Brake Lever, 2XS, Rigid	2
14, 15, 16, 17d	113219	Drum Brake Cable Kit with Brake Lever, XS, Rigid	2
14, 15, 16, 17e	113220	Drum Brake Cable Kit with Brake Lever, Short, Rigid	2
14, 15, 16, 17f	113196	Drum Brake Cable Kit with Brake Lever, Medium, Rigid	2
2, 3, 4a	113209	0° Camber Adapter Kit, Drum Brake	2
2, 3, 4b	113210	2° Camber Adapter Kit, Drum Brake	2
2, 3, 4c	113211	4° Camber Adapter Kit, Drum Brake	2

Item Number	Part Number	Description	Quantity
2, 3, 4d	113212	6° Camber Adapter Kit, Drum Brake	2
2, 3, 4e	113213	8° Camber Adapter Kit, Drum Brake	2
5, 6, 7, 8a, 8b, 9, 10, 11, 13, 18	113214	Drum Brake Rotor Kit with Hardware PAIR, Rigid	1
5, 6, 9, 10, 11, 13, 18	113215	Hardware Kit for Drum Brake Rotor PAIR, Rigid	1
5, 6, 7, 8a, 9, 10, 11, 13, 18	113239	Drum Brake Rotor Kit with Hardware, Side B, Rigid	1
5, 6, 7, 8b, 9, 10, 11, 13, 18	113240	Drum Brake Rotor Kit with Hardware, Side A, Rigid	1
5, 6, 9, 10, 11, 13, 18	113241	Hardware Kit for Drum Brake Rotor, One Side, Rigid	1
7	110635	Adapter, Drum Brake, Rigid	1
12a	111731	Wheel 20" MAXX Spoke, Drum Brake	2
12b	111732	Wheel 22" MAXX Spoke, Drum Brake	2
12c	111733	Wheel 24" MAXX Spoke, Drum Brake	2
12d	118358	24" Spoke for Drum Brake, Pneumatic w/ Airless Insert Tire (Black) <i>Replaced part number 117432. Does not include the handrim. Quote handrim hardware if needed.</i>	2
13	101108	Axle Quick Release w/ Button 1/2" x 99MM	2
14	111735	Brake Lever, Lock, Ang, 22mm	2
15	001117	Cable Clip 1"	2
16	001239	P-Clip 3/16"	2
17a	111605	Drum Brake / Hemi Wheel Lock 4XS Cable	2
17b	111606	Drum Brake / Hemi Wheel Lock 3XS Cable	2
17c	111545	Drum Brake / Hemi Wheel Lock 2XS Cable	2
17d	111546	Drum Brake / Hemi Wheel Lock XS Cable	2
17e	002468	Drum Brake / Hemi Wheel Lock Short Cable	2
17f	002469	Drum Brake / Hemi Wheel Lock Medium Cable	2
18	111598	Pinch Bolt	2
19a	000925	Camber Mount Tower Long Black Anodized Rigid	2
19b	000925_ _ _	Color Anodized/Color Accent Camber Mount Tower Long Rigid	2
19c	000926	Camber Mount Tower Extra Long Black Anodized Rigid	2

Item Number	Part Number	Description	Quantity
19d	000926_ _ _	Color Anodized/Color Accent Camber Mount Tower Extra Long Rigid	2
20	000920	Camber Mount Cap Rigid	2

Color Anodizing Samples

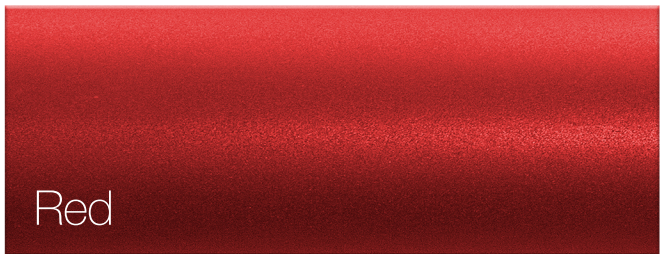
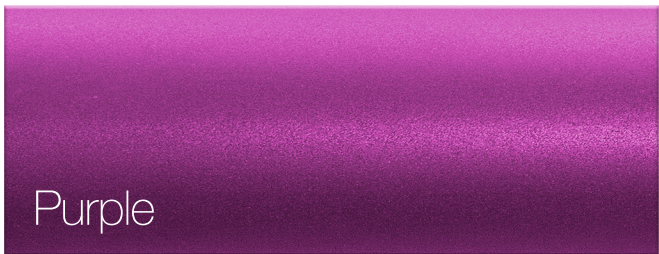
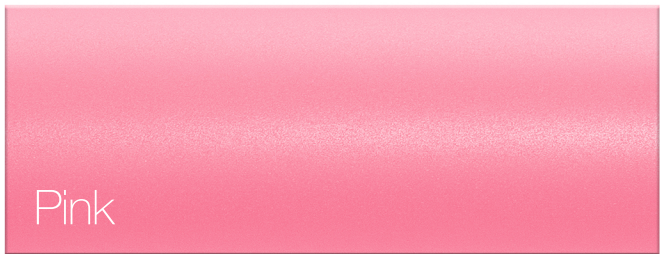
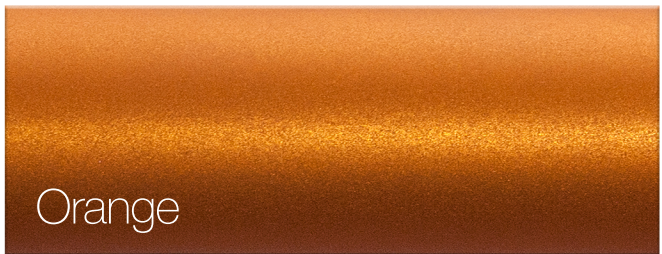
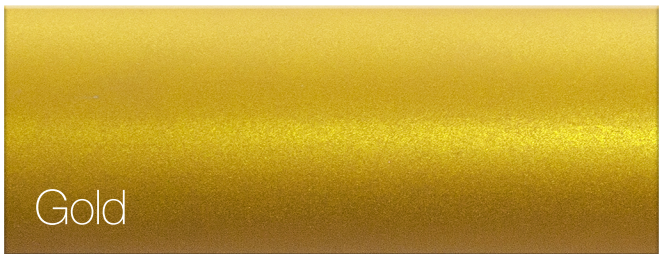
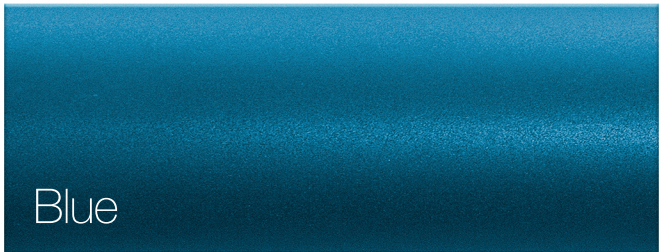
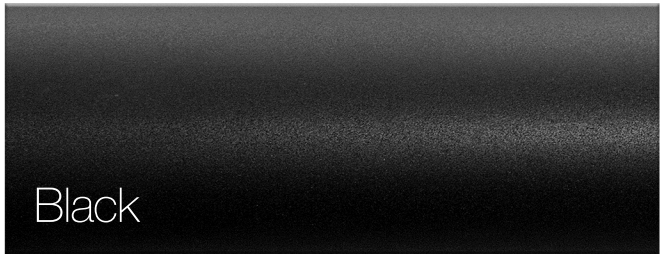

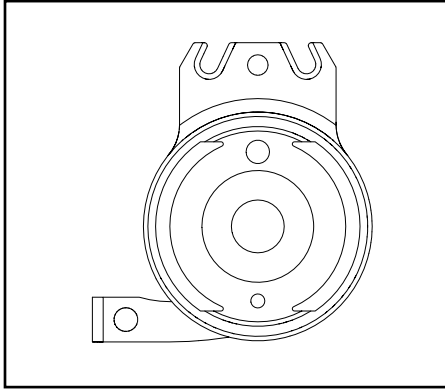

Rotor A - Part No. 111641

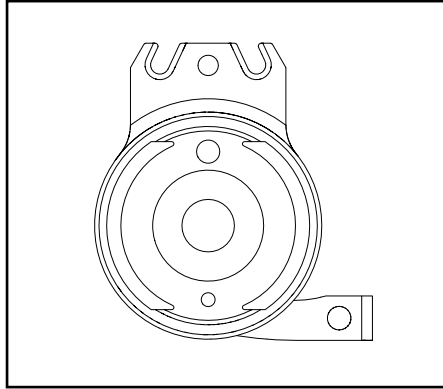

Rotor B - Part No. 111640

Catalyst 5		
Configuration	Left	Right
Axle plate curve up	B	A
Axle plate curve down	A	B

Left: Axle Plate Curve Up
Right: Axle Plate Curve Down

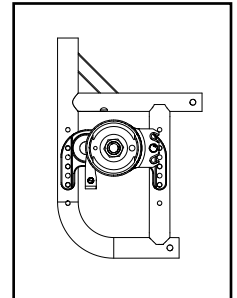
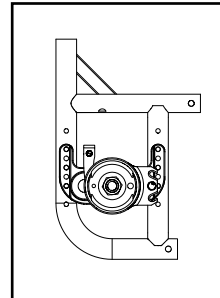

Catalyst 5VX		
Configuration	Left	Right
Axle Position holes 1-5 (top)	A	B
Axle Position holes 6-7 (bottom)	B	A

Left: Axle Position Top
Right: Axle Position Bottom

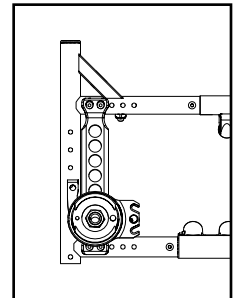
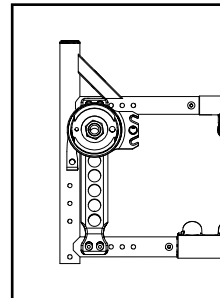

Liberty		
Configuration	Left	Right
All	B	A

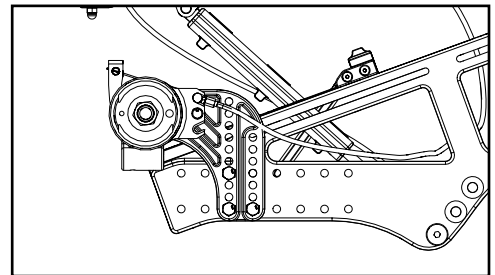

Flip		
Configuration	Left	Right
All	A	B

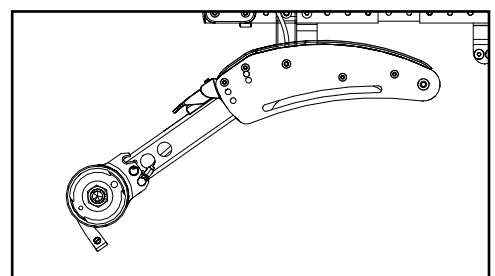

Focus		
Configuration	Left	Right
Standard (mounts above base frame)	A	B
Inverted (mounts below base frame)	B	A

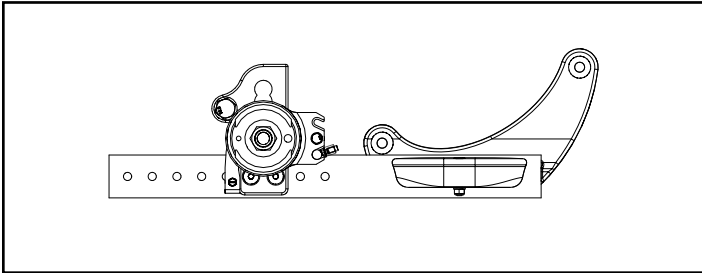

Standard Configuration

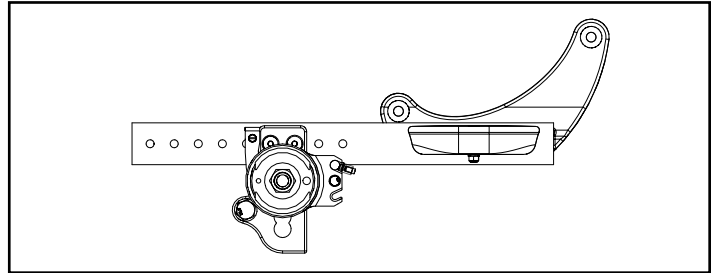

Inverted Configuration

Rigid		
Configuration	Left	Right
Tower 000925 - upper holes (14 or more exposed below clamp)	B	A
Tower 000925 - lower holes (13 or fewer holes exposed below clamp)	A	B
Tower 000926 (all hole locations)	A	B

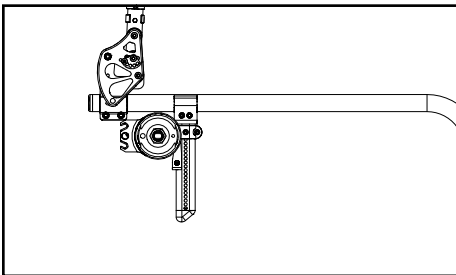

Tower 000925 - Upper Holes

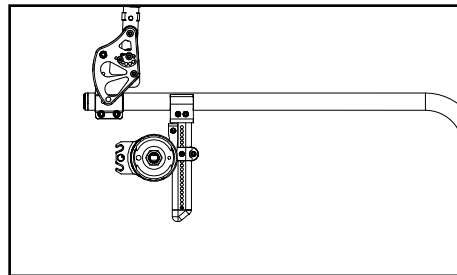

Tower 000925 - Lower Holes

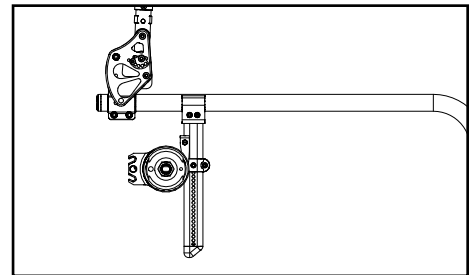

Tower 000926 - All Holes

Arc		
Configuration	Left	Right
All	B	A

