

Suggested Retail Price List

HCPCS E0642

January 2008

Phone: 1-800-236-4125

Fax: 602-279-0952

A (Axilla to Floor Height)

W (Wrist to Floor Height)

G (Groin to Floor Height)

H (Hip Width)

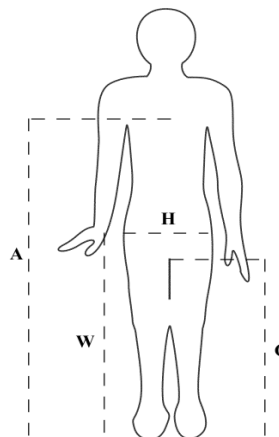

Features included in standard price:

- Angle Adjustable Frame
- Quick Release Wheels
- Central Braking System
- Four Casters



Measurements

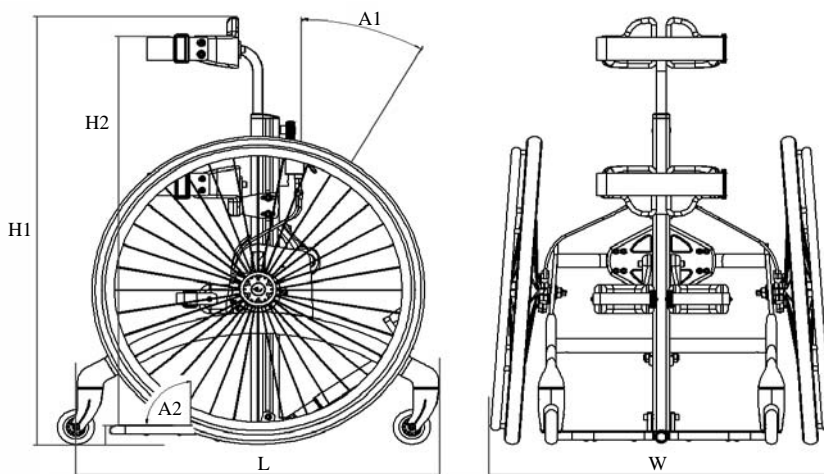

	Size 1 w/22" wheels cm (inch)	Size 2 w/26" wheels cm (inch)	Size 3 w/32" wheels cm (inch)	Size 4 w/36" wheels cm (inch)
Length (L)	24¼"	29¼"	29¼"	33¼"
Total length	24¼"	29¼"	31¼"	35"
Width (W)	22½"	26½"	27"	27¼"
Height from floor. Maximum Height (H1)	39"	46"	51"	59¾"
Height from floor. Minimum Height (H1)	26¼"	33¼"	38½"	46¾"
Height from foot plate. Maximum Height (H2)	29"	42"	46½"	54¼"
Height from foot plate. Minimum Height (H2)	22¼"	29¼"	33½"	41¼"
Angle of the center bar (A1)	0 to +30°	0 to +30°	0 to +30°	0 to +30°
Angle of the foot plate (A2)	+15° to -10°	+15° to -10°	+15° to -10°	+15° to -10°
Camber	4°	4°	4°	4°
Maximum user weight	89 lb	111 lb	133 lb	155 lb
Unit Weight	29½ lb	34 lb	35 lb	40½ lb





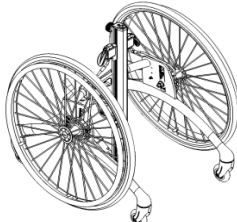

Rabbit January 2008 Price List







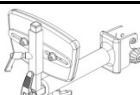

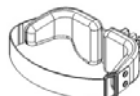
Account No. _____	Drop Ship: _____
Date: _____	Name: _____
P.O. Number: _____	Address: _____
Buyer: _____	City/St/Zip: _____
Marked For: _____	Telephone: _____
E Mail: _____	Fax Number: _____

Rabbit	Description	Size	Part No.	Price
	Rabbit, 22" wheels, red	1	862122	1,875 <input type="checkbox"/>
	Rabbit, 24" wheels, red	1	862124	1,875 <input type="checkbox"/>
	Rabbit, 26" wheels, red	1	862126	1,875 <input type="checkbox"/>
	Rabbit, 26" wheels, blue	2	862226	1,875 <input type="checkbox"/>
	Rabbit, 29" wheels, blue	2	862229	2,750 <input type="checkbox"/>
	Rabbit, 32" wheels, blue	2	862232	2,775 <input type="checkbox"/>
	Rabbit, 26" wheels, blue	3	862326	1,875 <input type="checkbox"/>
	Rabbit, 29" wheels, blue	3	862329	2,750 <input type="checkbox"/>
	Rabbit, 32" wheels, blue	3	862332	2,775 <input type="checkbox"/>
	Rabbit, 32" wheels, silver	4	862432	2,775 <input type="checkbox"/>
	Rabbit, 36" wheels, silver	4	862436	2,775 <input type="checkbox"/>

Accessories

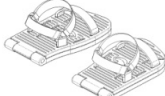
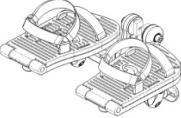
	Chest support, size 1 bar, size 2/3 chest pad	1	861706	175 <input type="checkbox"/>
	Chest support, Height & Width Adjustable	2+3	861702	175 <input type="checkbox"/>
	Chest support, Height & Width Adjustable	4	861703	195 <input type="checkbox"/>
	Extension for center bar, 3"	one size	861480	65 <input type="checkbox"/>
	Allow chest support to be mounted in a higher position			
	Tray with storage box	one size	862501	315 <input type="checkbox"/>
	<i>Can only be used with chest support</i>			
	Abdominal support	one size	861411	125 <input type="checkbox"/>
	Pommel and sacral support	one size	861401	370 <input type="checkbox"/>
	Hip support w/pommel, Height Adjustable	1	861501	465 <input type="checkbox"/>
	Hip support w/pommel, Height & Width Adjustable	2+3	861502	465 <input type="checkbox"/>
	Hip support w/pommel, Height & Width Adjustable	4	861503	488 <input type="checkbox"/>
	Hip support, Front mount, Height Adjustable	1	861601	195 <input type="checkbox"/>
	Hip support, Front mount, Hgt & Width Adjustable	2+3	861602	195 <input type="checkbox"/>
	Hip support, Front mount, Hgt & Width Adjustable	4	861603	215 <input type="checkbox"/>

	Description	Size	Part No.	Price	
	Hip support, rotational, Height Adjustable	1	861611	300	<input type="checkbox"/>
	Hip support, rotational, Height & Width Adjustable	2+3	861612	300	<input type="checkbox"/>
	Hip support, rotational, Height & Width Adjustable	4	861613	325	<input type="checkbox"/>
	Knee supports, including straps, set	1	861301	230	<input type="checkbox"/>
	Knee supports, including straps, set	2+3	861302	300	<input type="checkbox"/>
	Knee supports, including straps, set	4	861303	300	<input type="checkbox"/>
	Hinged knee supports, incl. strap	1	861311	355	<input type="checkbox"/>
	Hinged knee supports, incl. strap	2+3+4	861312	355	<input type="checkbox"/>
	Flip up foot plate	1	861211	175	<input type="checkbox"/>
	Flip up foot plate	2+3+4	861212	175	<input type="checkbox"/>
	Hinged sandals (for flip up foot plate), incl. straps	1	861221	110	<input type="checkbox"/>
	Hinged sandals (for flip up foot plate), incl. straps	2+3+4	861222	110	<input type="checkbox"/>
	Separate foot rests with hinged sandal, incl. straps	1	861201	325	<input type="checkbox"/>
	Separate foot rests with hinged sandal, incl. straps	2+3	861202	325	<input type="checkbox"/>
	Heel stop	one size	861251	46	<input type="checkbox"/>
	Spoke protector, pcs	22"	862622	105	<input type="checkbox"/>
	Spoke protector, pcs	24"	862624	105	<input type="checkbox"/>
	Spoke protector, pcs	26"	862626	105	<input type="checkbox"/>
	Spoke protector, pcs	29"	862629	145	<input type="checkbox"/>
	Spoke protector, pcs	32"	862632	145	<input type="checkbox"/>
	Spoke protector, pcs	36"	862636	145	<input type="checkbox"/>
Spare parts					
	Strap for hip support	1	861621	42	<input type="checkbox"/>
	Strap for hip support	2+3	861622	42	<input type="checkbox"/>
	Strap for hip support	4	861623	42	<input type="checkbox"/>
	Straps for knee support, set	1	861341	38	<input type="checkbox"/>
	Straps for knee support, set	2+3+4	861342	38	<input type="checkbox"/>
	Straps for Flip up foot plate sandals, set	1	861241	67	<input type="checkbox"/>
	Straps for Flip up foot plate sandals, set	2+3+4	861242	67	<input type="checkbox"/>

Description	Size	Part No.	Price
-------------	------	----------	-------

You must select a Swing-away Mounting Bracket and Headrest Style



HCPCS - E1028

Swing-away Bracket - Height, Depth, Angle & Lateral Adjustable

Mounting for Head support	1 & 2	861424-1	250	<input type="checkbox"/>
Mounting for Head support	3, 4, & 5	861424-2	250	<input type="checkbox"/>

HCPCS - E0955

Headrest Style



Head support no. 1		6171550	200	<input type="checkbox"/>
Head support no. 2		6172550	200	<input type="checkbox"/>
Head support no. 3		6173550	200	<input type="checkbox"/>
Head support no. 4		6174550	200	<input type="checkbox"/>

All of the Head Supports are Black Polyurethane