



JAY® J3 Form Back Support

E2617

January 2022

Mark For: _____ Date: _____ Dealer Acct #: _____ Dealer: _____ Dealer Contact: _____ Dealer Address: _____ Dealer City: _____ ST: _____ ZIP: _____ Dealer Phone: () _____ Fax: () _____ Confirmation Email: _____ Confirm Via: <input type="checkbox"/> Fax <input type="checkbox"/> Email	Submitting for: <input type="checkbox"/> Quote <input type="checkbox"/> Order PO#: _____ ADDITIONAL SHIPPING INFORMATION Ship To: _____ Attention: _____ Address: _____ Address: _____ Ship To City: _____ ST: _____ ZIP: _____ Ship To Phone: () _____ Fax: () _____
--	---

The **HCPCS CODES** herein are based on PDAC verification or interpretation of Medicare definitions and guidelines. Non-Medicare payers may accept alternative **HCPCS CODES**, including misc. codes to ensure access for their enrollees. The use of **HCPCS CODES** does not ensure coverage or payment.

JAY® J3 Form Back Support - E2617

Specifications Shell Contour (Without Foam) 2.2" Height 12" to 24.0" Cover Material 3DX™ Spacer w/Lycra® Stretch JAY J3 Hardware SH, TH, FS HCPCS E2617	Design <input type="checkbox"/> Utilizes the JAY® J3 PA design and hardware <input type="checkbox"/> Three foam-in-place densities: extra soft, soft and medium <input type="checkbox"/> Outer cover with offset band allows for the expansion of foam <input type="checkbox"/> Zipper location at top of cover to allow for access during installation (molding)	
---	--	---

STEP 1 - JAY J3 Form Posterior (PA) Back, Hardware Selection, and Accessories (pages 2-4)

BACKREST WIDTH	14"	16"	18"	20"
BACKCANE WIDTHS	14"-16"	16"-18"	18"-20"	20"-22"
MAX. USER TRUNK WIDTH	13"	15"	17"	19"

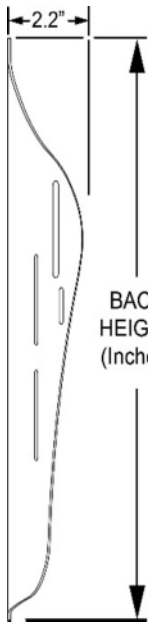
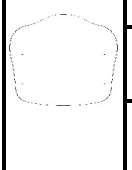
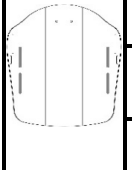
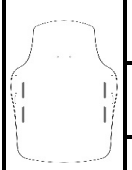
Back Height	Mid Thoracic (MT)					
	12.0" (S)	13.5" (M)	15.0" (T)			
		J3CUSTPAMTSxxSH	<input type="checkbox"/> 14 \$1,020	<input type="checkbox"/> 16 \$1,020	<input type="checkbox"/> 18 \$1,020	<input type="checkbox"/> 20 \$1,020
		J3CUSTPAMTSxxTH	<input type="checkbox"/> 14 \$1,068	<input type="checkbox"/> 16 \$1,068	<input type="checkbox"/> 18 \$1,068	<input type="checkbox"/> 20 \$1,068
		J3CUSTPAMTSxxFS	<input type="checkbox"/> 14 \$1,068	<input type="checkbox"/> 16 \$1,068	<input type="checkbox"/> 18 \$1,068	<input type="checkbox"/> 20 \$1,068
		J3CUSTPAMTMxxSH	<input type="checkbox"/> 14 \$1,020	<input type="checkbox"/> 16 \$1,020	<input type="checkbox"/> 18 \$1,020	<input type="checkbox"/> 20 \$1,020
		J3CUSTPAMTMxxTH	<input type="checkbox"/> 14 \$1,068	<input type="checkbox"/> 16 \$1,068	<input type="checkbox"/> 18 \$1,068	<input type="checkbox"/> 20 \$1,068
		J3CUSTPAMTMxxFS	<input type="checkbox"/> 14 \$1,068	<input type="checkbox"/> 16 \$1,068	<input type="checkbox"/> 18 \$1,068	<input type="checkbox"/> 20 \$1,068
		J3CUSTPAMTTxxSH	<input type="checkbox"/> 14 \$1,020	<input type="checkbox"/> 16 \$1,020	<input type="checkbox"/> 18 \$1,020	<input type="checkbox"/> 20 \$1,020
		J3CUSTPAMTTxxTH	<input type="checkbox"/> 14 \$1,068	<input type="checkbox"/> 16 \$1,068	<input type="checkbox"/> 18 \$1,068	<input type="checkbox"/> 20 \$1,068
		J3CUSTPAMTTxxFS	<input type="checkbox"/> 14 \$1,068	<input type="checkbox"/> 16 \$1,068	<input type="checkbox"/> 18 \$1,068	<input type="checkbox"/> 20 \$1,068
		Upper Thoracic (UT)				
		16.5" (S)	18.0" (M)	19.5" (T)		
		J3CUSTPAUTSxxSH	<input type="checkbox"/> 14 \$1,020	<input type="checkbox"/> 16 \$1,020	<input type="checkbox"/> 18 \$1,020	<input type="checkbox"/> 20 \$1,020
J3CUSTPAUTSxxTH		<input type="checkbox"/> 14 \$1,068	<input type="checkbox"/> 16 \$1,068	<input type="checkbox"/> 18 \$1,068	<input type="checkbox"/> 20 \$1,068	
J3CUSTPAUTSxxFS		<input type="checkbox"/> 14 \$1,068	<input type="checkbox"/> 16 \$1,068	<input type="checkbox"/> 18 \$1,068	<input type="checkbox"/> 20 \$1,068	
J3CUSTPAUTMxxSH		<input type="checkbox"/> 14 \$1,020	<input type="checkbox"/> 16 \$1,020	<input type="checkbox"/> 18 \$1,020	<input type="checkbox"/> 20 \$1,020	
J3CUSTPAUTMxxTH		<input type="checkbox"/> 14 \$1,068	<input type="checkbox"/> 16 \$1,068	<input type="checkbox"/> 18 \$1,068	<input type="checkbox"/> 20 \$1,068	
J3CUSTPAUTMxxFS		<input type="checkbox"/> 14 \$1,068	<input type="checkbox"/> 16 \$1,068	<input type="checkbox"/> 18 \$1,068	<input type="checkbox"/> 20 \$1,068	
J3CUSTPAUTTxxSH		<input type="checkbox"/> 14 \$1,020	<input type="checkbox"/> 16 \$1,020	<input type="checkbox"/> 18 \$1,020	<input type="checkbox"/> 20 \$1,020	
J3CUSTPAUTTxxTH	<input type="checkbox"/> 14 \$1,068	<input type="checkbox"/> 16 \$1,068	<input type="checkbox"/> 18 \$1,068	<input type="checkbox"/> 20 \$1,068		
J3CUSTPAUTTxxFS	<input type="checkbox"/> 14 \$1,068	<input type="checkbox"/> 16 \$1,068	<input type="checkbox"/> 18 \$1,068	<input type="checkbox"/> 20 \$1,068		
	Shoulder Height (SH)					
	21.0" (S)	22.5" (M)	24.0" (T)			
	J3CUSTPASHSxxSH	<input type="checkbox"/> 14 \$1,020	<input type="checkbox"/> 16 \$1,020	<input type="checkbox"/> 18 \$1,020	<input type="checkbox"/> 20 \$1,020	
	J3CUSTPASHSxxTH	<input type="checkbox"/> 14 \$1,068	<input type="checkbox"/> 16 \$1,068	<input type="checkbox"/> 18 \$1,068	<input type="checkbox"/> 20 \$1,068	
	J3CUSTPASHSxxFS	<input type="checkbox"/> 14 \$1,068	<input type="checkbox"/> 16 \$1,068	<input type="checkbox"/> 18 \$1,068	<input type="checkbox"/> 20 \$1,068	
	J3CUSTPASHMxxSH	<input type="checkbox"/> 16 \$1,020	<input type="checkbox"/> 18 \$1,020	<input type="checkbox"/> 20 \$1,020		
	J3CUSTPASHMxxTH	<input type="checkbox"/> 16 \$1,068	<input type="checkbox"/> 18 \$1,068	<input type="checkbox"/> 20 \$1,068		
	J3CUSTPASHMxxFS	<input type="checkbox"/> 16 \$1,068	<input type="checkbox"/> 18 \$1,068	<input type="checkbox"/> 20 \$1,068		
	J3CUSTPASHTxxSH	<input type="checkbox"/> 18 \$1,020	<input type="checkbox"/> 20 \$1,020			
J3CUSTPASHTxxTH	<input type="checkbox"/> 18 \$1,068	<input type="checkbox"/> 20 \$1,068				
J3CUSTPASHTxxFS	<input type="checkbox"/> 18 \$1,068	<input type="checkbox"/> 20 \$1,068				

MOUNTING HARDWARE OPTIONS

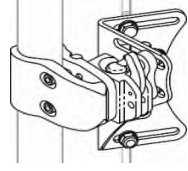

SH

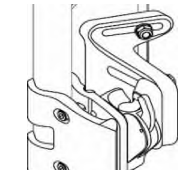

TH

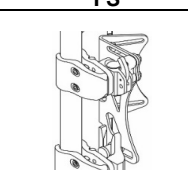

FS

STEP 2 - Foam-In-Place Selection

Note: Foam-In-Place must be ordered in combination with backrest & hardware (STEP 1), separate line during ordering process. Will ship separately from backrest & hardware, any JAY accessories, or bundled wheelchair. For spare parts please see www.sunparts.us



	Part #	Description	Price
<input checked="" type="checkbox"/>	251600	SUNMATE FOAM-IN-PLACE X-SOFT	INCLUDED
<input type="checkbox"/>	251601	SUNMATE FOAM-IN-PLACE SOFT	INCLUDED
<input type="checkbox"/>	251602	SUNMATE FOAM-IN-PLACE MEDIUM	INCLUDED

JAY J3 Back Accessories

All JAY J3 Plus Back accessories are optional. All accessories will be factory mounted as much as possible to insure proper shipping (If selected below).

SHIPPING INSTRUCTIONS

	Option #	HCPCS	Definition	Price		Option #	HCPCS	Definition	Price
<input checked="" type="checkbox"/>	N/A		Ship Back on Chair (Chair to be ordered separately)	NC	<input checked="" type="checkbox"/>	N/A		Ship accessories mounted on back	NC

Headrests

Use this section for selecting headrest. Head supports are not available on Mid Thoracic Back Shells

STEP 1

Select your HEADREST POST

Please select one box from the below **Headrest Mount & Bracket** choices.

<input type="checkbox"/>	J3HEDX	E1028	Axys Mount & Bracket	\$236.00	<input type="checkbox"/>	J3HEDO	E1028	ONYX Mount & Bracket	\$215.00
<input type="checkbox"/>	J3HEDL	E1028	LINX Mount & Bracket	\$301.00	<input type="checkbox"/>	J3HEDC	E1028	Cobra Mount & Bracket	\$301.00
<input type="checkbox"/>	J3HEDL2	E1028	LINX ² Mount & Bracket	\$333.00	<input type="checkbox"/>	J3HEDF	E1028	Cobra Flip Back Mount and Bracket	\$376.00

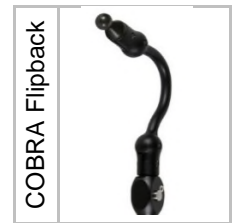
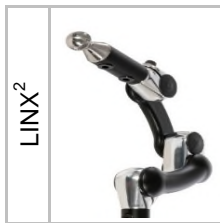
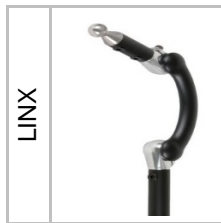

STEP 2

Select your HEADREST PAD

Please select one box from the below **Headrest Pad** choices.

<input type="checkbox"/>	14	E0955	J3PLSH14 - 14" Plush Pad	\$186.00	<input type="checkbox"/>	AAPS	E0955	J3AAPS - Adjust-A-Plush Standard (Lg)	\$279.00
<input type="checkbox"/>	10	E0955	J3PLSH10 - 10" Plush Pad	\$173.00	<input type="checkbox"/>	AAPM	E0955	J3AAPS - Adjust-A-Plush Medium	\$279.00
<input type="checkbox"/>	8	E0955	J3PLSH8 - 8" Plush Pad	\$173.00	<input type="checkbox"/>	AAPN	E0955	J3AAPS - Adjust-A-Plush Narrow (Sm)	\$279.00
<input type="checkbox"/>	HUPL	E0955	J3HUPL - HeadsUp Lrg: 5.3" Lng Arms	\$333.00	<input type="checkbox"/>	CL	E0955	J3CRDLLG - Lrg Contour Cradle Pad	\$166.00
<input type="checkbox"/>	HUPM	E0955	J3HUPM - HeadsUp Med: 4.1" Sht Arms	\$333.00	<input type="checkbox"/>	CM	E0955	J3CRDLMD - Med Contour Cradle Pad	\$154.00
<input type="checkbox"/>	HUPS	E0955	J3HUPS - HeadsUp Sml: 3.5" Sht Arms	\$333.00	<input type="checkbox"/>	PL	E0955	J3CPLULG - Large C-Plush Pad	\$166.00
					<input type="checkbox"/>	PM	E0955	J3CPLUMD - Medium C-Plush Pad	\$166.00

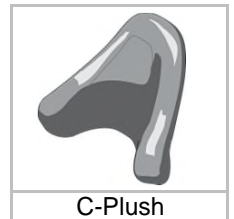
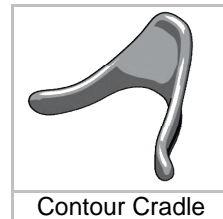
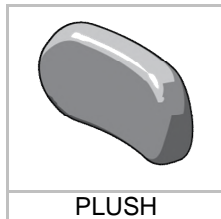

STEP 1 Headrest Post Example = J3HEDX	+	STEP 2 Headrest Pad # Example = 14	=	COMPLETED JAY J3 Headrest # Example = J3HEDX14
--	---	---	---	---

UNIVERSAL MOUNTING PLATE

<input type="checkbox"/>	J3UHM	K0108	Universal Headrest Mounting Plate Only	\$56.00
--------------------------	-------	-------	--	---------

Lateral Supports

Use this section for selecting laterals and hardware. Lateral supports are not available on Lower Thoracic Back Shells

Lateral Thoracic Support (Fixed)

Includes fixed mounting hardware. Lateral pads use 3DX covers with 1/2" Sunmate foam in the core

<input type="checkbox"/>	J3LAT4X4FX	E0956	LATERAL 4" Depth X 4" Height FIXED	\$269.00	<input type="checkbox"/>	J3LAT6X4FX	E0956	LATERAL 6" Depth X 4" Height FIXED	\$269.00
<input type="checkbox"/>	J3LAT4X5FX	E0956	LATERAL 4" Depth X 5" Height FIXED	\$269.00	<input type="checkbox"/>	J3LAT6X5FX	E0956	LATERAL 6" Depth X 5" Height FIXED	\$269.00
<input type="checkbox"/>	J3LAT4x6FX	E0956	LATERAL 4" Depth X 6" Height FIXED	\$269.00	<input type="checkbox"/>	J3LAT6X6FX	E0956	LATERAL 6" Depth X 6" Height FIXED	\$269.00

J3 Swing-Away Lateral Thoracic Support (Pairs)

<input type="checkbox"/>	J3LAT4X4SA		LAT 4X4 W/ S/A MOUNTS - PR	\$836.00	<input type="checkbox"/>	J3LAT6X4SA		LAT 6X4 W/ S/A MOUNTS - PR	\$836.00
	J3LAT4X4	E0956	LATERAL 4" Depth X 4" Height - PAIR	\$270.00		J3LAT6X4	E0956	LATERAL 6" Depth X 4" Height - PAIR	\$270.00
	J3SAMNT	E1028	LATERAL SWING AWAY MOUNT - PAIR	\$566.00		J3SAMNT	E1028	LATERAL SWING AWAY MOUNT - PAIR	\$566.00
<input type="checkbox"/>	J3LAT4X5SA		LAT 4X5 W/ S/A MOUNTS - PR	\$836.00	<input type="checkbox"/>	J3LAT6X5SA		LAT 6X5 W/ S/A MOUNTS - PR	\$836.00
	J3LAT4X5	E0956	LATERAL 4" Depth X 5" Height - PAIR	\$270.00		J3LAT6X5	E0956	LATERAL 6" Depth X 5" Height - PAIR	\$270.00
	J3SAMNT	E1028	LATERAL SWING AWAY MOUNT - PAIR	\$566.00		J3SAMNT	E1028	LATERAL SWING AWAY MOUNT - PAIR	\$566.00
<input type="checkbox"/>	J3LAT4X6SA		LAT 4X6 W/ S/A MOUNTS - PR	\$836.00	<input type="checkbox"/>	J3LAT6X6SA		LAT 6X6 W/ S/A MOUNTS - PR	\$836.00
	J3LAT4X6	E0956	LATERAL 4" Depth X 6" Height - PAIR	\$270.00		J3LAT6X6	E0956	LATERAL 6" Depth X 6" Height - PAIR	\$270.00
	J3SAMNT	E1028	LATERAL SWING AWAY MOUNT - PAIR	\$566.00		J3SAMNT	E1028	LATERAL SWING AWAY MOUNT - PAIR	\$566.00
<input type="checkbox"/>	J3LAT4X4SAO		LAT 4X4 S/A MOUNTS W/ 1" OFFSET - PR	\$836.00	<input type="checkbox"/>	J3LAT6X4SAO		LAT 6X4 S/A MOUNTS W/ 1" OFFSET - PR	\$836.00
	J3LAT4X4O	E0956	LATERAL 4" D X 4" H W/ 1" OFFSET - PAIR	\$270.00		J3LAT6X4O	E0956	LATERAL 6" D X 4" H W/ 1" OFFSET - PAIR	\$270.00
	J3SAMNT	E1028	LATERAL SWING AWAY MOUNT - PAIR	\$566.00		J3SAMNT	E1028	LATERAL SWING AWAY MOUNT - PAIR	\$566.00
<input type="checkbox"/>	J3LAT4X5SAO		LAT 4X5 S/A MOUNTS W/ 1" OFFSET - PR	\$836.00	<input type="checkbox"/>	J3LAT6X5SAO		LAT 6X5 S/A MOUNTS W/ 1" OFFSET - PR	\$836.00
	J3LAT4X5O	E0956	LATERAL 4" D X 5" H W/ 1" OFFSET - PAIR	\$270.00		J3LAT6X5O	E0956	LATERAL 6" D X 5" H W/ 1" OFFSET - PAIR	\$270.00
	J3SAMNT	E1028	LATERAL SWING AWAY MOUNT - PAIR	\$566.00		J3SAMNT	E1028	LATERAL SWING AWAY MOUNT - PAIR	\$566.00
<input type="checkbox"/>	J3LAT4X6SAO		LAT 4X6 S/A MOUNTS W/ 1" OFFSET - PR	\$836.00	<input type="checkbox"/>	J3LAT6X6SAO		LAT 6X6 S/A MOUNTS W/ 1" OFFSET - PR	\$836.00
	J3LAT4X6O	E0956	LATERAL 4" D X 6" H W/ 1" OFFSET - PAIR	\$270.00		J3LAT6X6O	E0956	LATERAL 6" D X 6" H W/ 1" OFFSET - PAIR	\$270.00
	J3SAMNT	E1028	LATERAL SWING AWAY MOUNT - PAIR	\$566.00		J3SAMNT	E1028	LATERAL SWING AWAY MOUNT - PAIR	\$566.00



Swing-Away Lateral Thoracic Support

Includes: Swing-away mounting hardware, left and right lateral are independent. Different types and sizes can be selected for each side.

Left Side				
<input type="checkbox"/>	JLATA44L		LAT 4X4 W/ S/A MOUNTS - LH	\$418.00
	JLAT4X4	E0956	Lateral 4" Depth X 4" Height	\$135.00
	JSAMNTL	E1028	Lateral Swing Away Mount - Left	\$283.00
<input type="checkbox"/>	JLATA45L		LAT 4X5 W/ S/A MOUNTS - LH	\$418.00
	JLAT4X5	E0956	LATERAL 4" Depth X 5" Height	\$135.00
	JSAMNTRL	E1028	Lateral Swing Away Mount - Left	\$283.00
<input type="checkbox"/>	JLATA46L		LAT 4X6 W/ S/A MOUNTS - LH	\$418.00
	JLAT4X6	E0956	LATERAL 4" Depth X 6" Height	\$135.00
	JSAMNTL	E1028	Lateral Swing Away Mount - Left	\$283.00
<input type="checkbox"/>	JLATA64L		LAT 6X4 W/ S/A MOUNTS - LH	\$418.00
	JLAT6X4	E0956	LATERAL 6" Depth X 4" Height	\$135.00
	JSAMNTL	E1028	Lateral Swing Away Mount - Left	\$283.00
<input type="checkbox"/>	JLATA65L		LAT 6X5 W/ S/A MOUNTS - LH	\$418.00
	JLAT6X5	E0956	LATERAL 6" Depth X 5" Height	\$135.00
	JSAMNTL	E1028	Lateral Swing Away Mount - Left	\$283.00
<input type="checkbox"/>	JLATA66L		LAT 6X6 W/ S/A MOUNTS - LH	\$418.00
	JLAT6X6	E0956	LATERAL 6" Depth X 6" Height	\$135.00
	JSAMNTL	E1028	Lateral Swing Away Mount - Left	\$283.00

Right Side				
<input type="checkbox"/>	JLATA44R		LAT 4X4 W/ S/A MOUNTS - RH	\$418.00
	JLAT4X4	E0956	Lateral 4" Depth X 4" Height	\$135.00
	JSAMNTR	E1028	Lateral Swing Away Mount - Right	\$283.00
<input type="checkbox"/>	JLATA45R		LAT 4X5 W/ S/A MOUNTS - RH	\$283.00
	JLAT4X5	E0956	Lateral 4" Depth X 5" Height	\$135.00
	JSAMNTR	E1028	Lateral Swing Away Mount - Right	\$283.00
<input type="checkbox"/>	JLATA46R		LAT 4X6 W/ S/A MOUNTS - RH	\$418.00
	JLAT4X6	E0956	Lateral 4" Depth X 6" Height	\$135.00
	JSAMNTR	E1028	Lateral Swing Away Mount - Right	\$283.00
<input type="checkbox"/>	JLATA64R		LAT 6X4 W/ S/A MOUNTS - RH	\$418.00
	JLAT6X4	E0956	Lateral 6" Depth X 4" Height	\$135.00
	JSAMNTR	E1028	Lateral Swing Away Mount - Right	\$283.00
<input type="checkbox"/>	JLATA65R		LAT 6X5 W/ S/A MOUNTS - RH	\$418.00
	JLAT6X5	E0956	Lateral 6" Depth X 5" Height	\$135.00
	JSAMNTR	E1028	Lateral Swing Away Mount - Right	\$283.00
<input type="checkbox"/>	JLATA66R		LAT 6X6 W/ S/A MOUNTS - RH	\$418.00
	JLAT6X6	E0956	Lateral 6" Depth X 6" Height	\$135.00
	JSAMNTR	E1028	Lateral Swing Away Mount - Right	\$283.00

Spine-Align Positioning Components

J3 Back LT models come standard with a Small Lumbar, MT, UT and SH models come standard with a small and large lumbar.

SPINE-ALIGN MINI FIT KIT 1

Includes: 3 wedges, 2 lateral shims, and 2 posterior/lateral pelvic positioning pads.

<input type="checkbox"/>	J3SPNK112	K0108	SPINE-ALIGN MINI FIT KIT 1 (12")	\$108.00
<input type="checkbox"/>	J3SPNK114	K0108	SPINE-ALIGN MINI FIT KIT 1 (14")	\$108.00
<input type="checkbox"/>	J3SPNK116	K0108	SPINE-ALIGN MINI FIT KIT 1 (16")	\$108.00
<input type="checkbox"/>	J3SPNK118	K0108	SPINE-ALIGN MINI FIT KIT 1 (18")	\$108.00
<input type="checkbox"/>	J3SPNK120	K0108	SPINE-ALIGN MINI FIT KIT 1 (20")	\$108.00

SPINE-ALIGN MINI FIT KIT 2

Includes: 5 wedges, 2 lat shims, 2 post/lat pelvic, 1 lg lumbar, 1 flat shim, and 1 curved

<input type="checkbox"/>	J3SPNK212	K0108	SPINE-ALIGN MINI FIT KIT 2 (12")	\$149.00
<input type="checkbox"/>	J3SPNK214	K0108	SPINE-ALIGN MINI FIT KIT 2 (14")	\$149.00
<input type="checkbox"/>	J3SPNK216	K0108	SPINE-ALIGN MINI FIT KIT 2 (16")	\$149.00
<input type="checkbox"/>	J3SPNK218	K0108	SPINE-ALIGN MINI FIT KIT 2 (18")	\$149.00
<input type="checkbox"/>	J3SPNK220	K0108	SPINE-ALIGN MINI FIT KIT 2 (20")	\$149.00

LARGE LUMBAR PADS (Back Width) (W" x H" x D")

<input type="checkbox"/>	J3SPNLL12	K0108	LG LUMBAR (12") (3.5" x 7" x 1.6")	\$47.00
<input type="checkbox"/>	J3SPNLL14	K0108	LG LUMBAR (14") (3.5" x 7" x 1.6")	\$47.00
<input type="checkbox"/>	J3SPNLL16	K0108	LG LUMBAR (16") (5.5" x 7" x 1.6")	\$47.00
<input type="checkbox"/>	J3SPNLL18	K0108	LG LUMBAR (18") (7.5" x 7" x 1.6")	\$47.00
<input type="checkbox"/>	J3SPNLL20	K0108	LG LUMBAR (20") (9.5" x 7" x 1.6")	\$47.00

SMALL LUMBAR PADS (Back Width) (W" x H" x D")







<input type="checkbox"/>	J3SPNSL12	K0108	SML LUMBAR (12") (1.8" x 3.2" x 0.8")	\$45.00
<input type="checkbox"/>	J3SPNSL14	K0108	SML LUMBAR (14") (3.5" x 4.3" x 1")	\$45.00
<input type="checkbox"/>	J3SPNSL16	K0108	SML LUMBAR (16") (5.5" x 4.3" x 1")	\$45.00
<input type="checkbox"/>	J3SPNSL18	K0108	SML LUMBAR (18") (7.5" x 4.3" x 1")	\$45.00
<input type="checkbox"/>	J3SPNSL20	K0108	SML LUMBAR (20") (9.5" x 4.3" x 1")	\$45.00

WEDGES (Back Width) (W" x H" x D")

<input type="checkbox"/>	J3SPNWE12	K0108	WEDGES (12") (3.5" x 6.5" x 1.6")	\$35.00
<input type="checkbox"/>	J3SPNWE14	K0108	WEDGES (14") (3.5" x 6.5" x 1.6")	\$35.00
<input type="checkbox"/>	J3SPNWE16	K0108	WEDGES (16") (5.5" x 6.5" x 1.6")	\$35.00
<input type="checkbox"/>	J3SPNWE18	K0108	WEDGES (18") (7.5" x 6.5" x 1.6")	\$35.00
<input type="checkbox"/>	J3SPNWE20	K0108	WEDGES (20") (9.5" x 6.5" x 1.6")	\$35.00

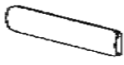
OTHER INDIVIDUAL SPINE-ALIGN COMPONENTS

<input type="checkbox"/>	J3SPNCR	K0108	Curved Shim	\$26.00
<input type="checkbox"/>	J3SPNBS	K0108	Small Bean Bag	\$29.00
<input type="checkbox"/>	J3SPNFL	K0108	Flat Shim	\$26.00
<input type="checkbox"/>	J3SPNBL	K0108	Large Bean Bag	\$32.00
<input type="checkbox"/>	J3SPNLS	K0108	Lateral Shim	\$51.00
<input type="checkbox"/>	J3SPNLP	K0108	Posterior/Lateral Pelvic	\$51.00

									
	Sm Lumbar	Lg Lumbar	Wedge	Curved Slim	Flat	Lateral Slim	Sm Bean Bag	Lg Bean Bag	Post/Lat Pelvic
W	1.8" - 9.5"	3.5" - 9.5"	3.5" - 9.5"	10"	10"	2.4"	6"	10"	5.3"
H	3.2" - 4.3"	7"	6.5"	4"	4"	4.3"	4.5"	3.2"	3.6"
D	0.8" - 1"	1.6"	1.6"	0.5"	0.3"	0.5"	0.75"	0.75"	0.75"

Chest Straps, Harnesses and Brackets

Use this section for selecting harnesses. Harnesses are not available on Lower Thoracic Back Shells

CHEST STRAPS & HARNESSSES (Includes strap guides & mounting hardware)

<input type="checkbox"/>	J3HRNCOS	E0960	Center Opening w/ Buckle (Sml)	\$163.00	<input type="checkbox"/>	J3HRNTDS	E0960	Contoured-Dynamic Pull Down (Sml)	\$163.00
<input type="checkbox"/>	J3HRNCOM	E0960	Center Opening w/ Buckle (Med)	\$163.00	<input type="checkbox"/>	J3HRNTDM	E0960	Contoured-Dynamic Pull Down (Med)	\$163.00
<input type="checkbox"/>	J3HRNCOL	E0960	Center Opening w/ Buckle (Lrg)	\$163.00	<input type="checkbox"/>	J3HRNTDL	E0960	Contoured-Dynamic Pull Down (Lrg)	\$163.00
<input type="checkbox"/>	J3HRNCOX	E0960	Center Opening w/ Buckle (X-Lrg)	\$163.00	<input type="checkbox"/>	J3HRNTDX	E0960	Contoured-Dynamic Pull Down (X-Lrg)	\$163.00
<input type="checkbox"/>	J3HRNCDS	E0960	Classic-Dynamic Pull Down (Sml)	\$163.00	<input type="checkbox"/>	J3HRNTSS	E0960	Contoured-Structured Pull Down (Sml)	\$163.00
<input type="checkbox"/>	J3HRNCDM	E0960	Classic-Dynamic Pull Down (Med)	\$163.00	<input type="checkbox"/>	J3HRNTSM	E0960	Contoured-Structured Pull Down (Med)	\$163.00
<input type="checkbox"/>	J3HRNCDL	E0960	Classic-Dynamic Pull Down (Lrg)	\$163.00	<input type="checkbox"/>	J3HRNTSL	E0960	Contoured-Structured Pull Down (Lrg)	\$163.00
<input type="checkbox"/>	J3HRNCDX	E0960	Classic-Dynamic Pull Down (X-Lrg)	\$163.00	<input type="checkbox"/>	J3HRNTSX	E0960	Contoured-Structured Pull Down (X-Lrg)	\$163.00
<input type="checkbox"/>	J3HRNCSS	E0960	Classic-Structured Pull Down (Sml)	\$163.00	<input type="checkbox"/>	J3HRNPSS	E0960	Padded Anterior Trunk Straps (Sml)	\$152.00
<input type="checkbox"/>	J3HRNCSSM	E0960	Classic-Structured Pull Down (Med)	\$163.00	<input type="checkbox"/>	J3HRNPSSM	E0960	Padded Anterior Trunk Straps (Med)	\$152.00
<input type="checkbox"/>	J3HRNCSSL	E0960	Classic-Structured Pull Down (Lrg)	\$163.00	<input type="checkbox"/>	J3HRNPSSL	E0960	Padded Anterior Trunk Straps (Lrg)	\$152.00
<input type="checkbox"/>	J3HRNCSSX	E0960	Classic-Structured Pull Down (X-Lrg)	\$163.00	<input type="checkbox"/>	J3HRNPSSX	E0960	Padded Anterior Trunk Straps (X-Lrg)	\$152.00

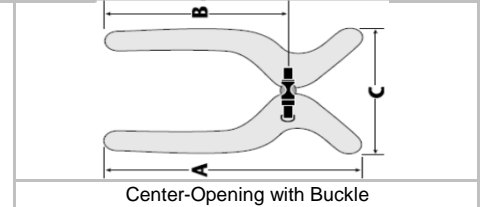
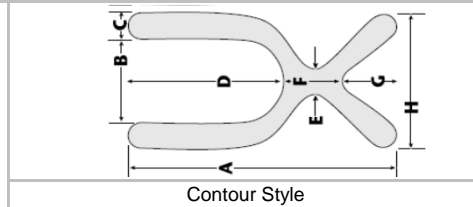
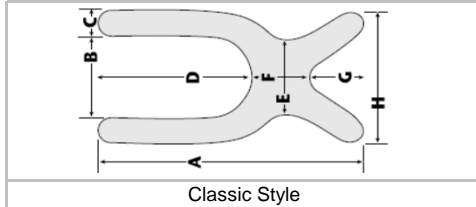

	A	B	C	D	E	F	G	H
S	15"	4.5"	2"	9"	4"	4"	2"	8.5"
M	19"	5.5"	2"	11"	5"	5"	3"	9.5"
L	22.5"	6.5"	2"	13"	6"	6"	3.5"	10.5"
XL	25.5"	6.5"	2.5"	14"	7"	7"	4.5"	11.5"

	A	B	C	D	E	F	G	H
S	15"	4.5"	2"	9"	1"	4"	2"	8.5"
M	18.5"	5.5"	2"	11"	1"	5"	2.5"	9.5"
L	22.5"	6.5"	2"	13"	1.5"	6"	3.5"	10.5"
XL	25.5"	6.5"	2.5"	14"	1.5"	7"	4.5"	11.5"

	A	B	C
S	12.3"	9"	6.5"
M	14.3"	11"	9.8"
L	15.5"	11.5"	9.8"
XL	17.5"	12.8"	10"

GUIDE BRACKETS & HARDWARE ONLY

<input type="checkbox"/>	J3GPSG	K0108	Guide Brackets Only - Pair	\$44.00	<input type="checkbox"/>	J3HHP	K0108	Hardware Pack Only	\$21.00
--------------------------	--------	-------	----------------------------	---------	--------------------------	-------	-------	--------------------	---------

VANITY FLAP

<input type="checkbox"/>	117096	K0108	12" to 14" Wide	\$48.00	<input type="checkbox"/>	117099	K0108	18" to 20" Wide	\$48.00
<input type="checkbox"/>	117097	K0108	14" to 16" Wide	\$48.00	<input type="checkbox"/>	117100	K0108	20" to 22" Wide	\$48.00
<input type="checkbox"/>	117098	K0108	16" to 18" Wide	\$48.00					

JAY YOUR WAY MODIFICATIONS

To order sizes offered via JAY Your Way add a "M" to the front of the part number and follow the prompts.

For additional modifications visit www.sunrisemedical.com.

PAINTED BACK SHELL

<input type="checkbox"/>	SBC	Painted Back Shell	NC
Color:		<input type="checkbox"/> Match Quickie or Zippie Frame Color	

Note: Backshells can be painted any Quickie Or Zippie Frame color at no charge please specify the desired color in the NOTES box below. For a full listing of frame colors available please visit www.sunrisemedical.com

MILITARY SERVICE PATCHES

<input type="checkbox"/>	VAPH	Purple Heart Service Patch	NC
<input type="checkbox"/>	VAM	Marine Service Patch	NC
<input type="checkbox"/>	VAA	Army Service Patch	NC
<input type="checkbox"/>	VAAF	Air Force Service Patch	NC
<input type="checkbox"/>	VAN	Navy Service Patch	NC
<input type="checkbox"/>	VACG	Coast Guard Service Patch	NC

EMBROIDERY

<input type="checkbox"/>	EMBROIDERY	K0108	Embroidery (32 Character Max)	\$23.00
Location:		<input type="checkbox"/> Front		
Font:		<input type="checkbox"/> Block <input type="checkbox"/> Script		
Embroidery Text:				
Embroidery Color:				

COVER OPTIONS - Contact Surface

<input type="checkbox"/>	DBS	Dartex Back Surface	NC
<input type="checkbox"/>	3DXBS	3DX Back Surface	NC
<input type="checkbox"/>	RDBS	Reverse Dartex Back Surface	NC

COVER OPTIONS - Rear Center Flap

<input type="checkbox"/>	DCC	Digital Camouflage Cover	NC
<input type="checkbox"/>	CBC	Black Cover	NC
<input type="checkbox"/>	CBCI	Black Incontinence Cover	NC

SPINAL FLUID PAD

<input type="checkbox"/>	SFPS	Small Spinal Fluid Pad (16" Height)	\$54.00
<input type="checkbox"/>	SFPM	Medium Spinal Fluid Pad (18" Height)	\$54.00
<input type="checkbox"/>	SFPT	Tall Spinal Fluid Pad (20" Height)	\$54.00
<input type="checkbox"/>	SFPXT	Extra Tall Spinal Fluid Pad (23" Height)	\$54.00

Don't see the option you want? NO PROBLEM! Write your request below and we can evaluate it and provide a quote.

Notes: