

Focus CR Drum Brake (Hand Tilt)

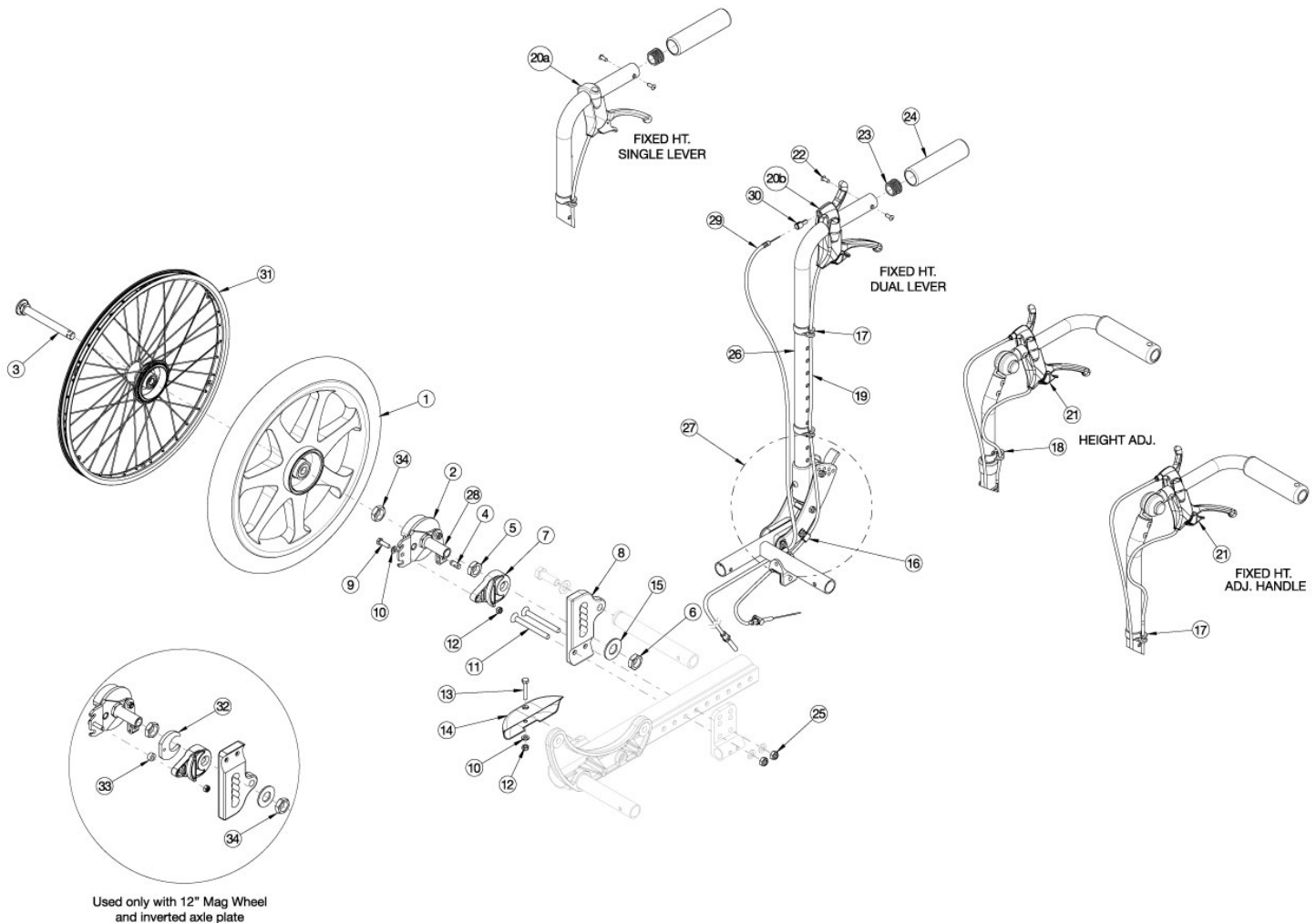

For complete retrofit, quote drum brake retro kit and cable kit. Must also quote rear tires and handrims if quoting 24" MAXX Spoke wheels. If retrofitting and chair was invoiced prior to October 11th, 2019, with stroller handle back posts present, new stroller handle back post assemblies are required. If changing wheel type and the drum brake is already present, the drum brake rotor kit with hardware is required.

Item Number	Part Number	Description	Quantity
1a, 2a, 2b, 3a, 4-8, 9a, 9b, 10-12, 15, 25, 28a, 32-34	113355	Drum Brake Retro Kit, 12" Mag w/Pneumatic Tire, PAIR, TILT	1
1b, 2a, 2b, 3a, 4-8, 9a, 9b, 10-12, 15, 25, 28a, 32-34	113356	Drum Brake Retro Kit, 12" Mag w/ Full Poly Tire, PAIR, TILT	1
1c, 2a, 2b, 3a, 4-12, 15, 25, 28a	502692	Drum Brake Retro Kit, 16" Mag w/ Pneumatic Tire, PAIR, TILT	1
1d, 2a, 2b, 3a, 4-12, 15, 25, 28a	502694	Drum Brake Retro Kit, 16" Mag w/ Full Poly Tire, PAIR, TILT	1

Item Number	Part Number	Description	Quantity
1e, 2a, 2b, 3a, 4-12, 15, 25, 28a	502693	Drum Brake Retro Kit, 16" Mag w/ Airless Insert Tire, PAIR, TILT	1
2a, 2b, 3b, 4-12, 15, 25, 28b, 31	113357	Drum Brake Retro Kit, 24" MAXX Spoke, PAIR, TILT <i>This retrofit kit does not contain rear tires or handrims</i>	1
2a, 2b, 3b, 4-12, 15, 25, 28b, 31	118245	Drum Brake Retro Kit, 24" MAXX Spoke, Pneumatic w/ Airless Insert Tire (Black), PAIR, TILT <i>Replaced kit number 116575</i>	1
12, 16, 17, 19a, 20a, 20b, 22-24, 26a, 29a, 30	114087	Cable Kit, Drum Brake w/Right Hand Tilt, Stroller Handle Back Post Short, Std Axle Plate	1
12, 16, 17, 19b, 20a, 20b, 22-24, 26b, 29b, 30	114088	Cable Kit, Drum Brake w/Right Hand Tilt, Stroller Handle Back Post Tall, Std Axle Plate	1
12, 16, 17, 19b, 20a, 20b, 22-24, 26a, 29a, 30	114089	Cable Kit, Drum Brake w/Right Hand Tilt, Stroller Handle Back Post Short, Inv Axle Plate	1
12, 16, 17, 19c, 20a, 20b, 22-24, 26b, 29b, 30	114090	Cable Kit, Drum Brake w/Right Hand Tilt, Stroller Handle Back Post Tall, Inv Axle Plate	1
12, 16, 17, 19a, 20a, 20b, 22-27, 29a, 30	114091	Cable Kit w/ Folding Hardware, Drum Brake w/Right Hand Tilt, Stroller Handle Back Post Short, Std Axle Plate	1
12, 16, 17, 19b, 20a, 20b, 22-27, 29b, 30	114092	Cable Kit w/ Folding Hardware, Drum Brake w/Right Hand Tilt, Stroller Handle Back Post Tall, Std Axle Plate	1
12, 16, 17, 19b, 20a, 20b, 22-27, 29a, 30	114093	Cable Kit w/ Folding Hardware, Drum Brake w/Right Hand Tilt, Stroller Handle Back Post Short, Inv Axle Plate	1
12, 16, 17, 19c, 20a, 20b, 22-27, 29b, 30	114094	Cable Kit w/ Folding Hardware, Drum Brake w/Right Hand Tilt, Stroller Handle Back Post Tall, Inv Axle Plate	1
16-18, 19c, 21a, 21b, 29b, 30	114095	Cable Kit, Drum Brake w/Right Hand Tilt, Ht Adj Back Post Short, Back Height 18-21", Std Axle Plate	1
16-18, 19c, 21a, 21b, 29c, 30	114096	Cable Kit, Drum Brake w/Right Hand Tilt, Ht Adj Back Post Short, Back Height 22-25", Std Axle Plate	1
16-18, 19d, 21a, 21b, 29c, 30	114097	Cable Kit, Drum Brake w/Right Hand Tilt, Ht Adj Back Post Tall, Back Height 20-25", Std Axle Plate	1
16-18, 19d, 21a, 21b, 29d, 30	114098	Cable Kit, Drum Brake w/Right Hand Tilt, Ht Adj Back Post Tall, Back Height 26-27", Std Axle Plate	1
16-18, 19d, 21a, 21b, 29b, 30	114099	Cable Kit, Drum Brake w/Right Hand Tilt, Ht Adj Back Post Short, Back Height 18-21", Inv Axle Plate	1
16-18, 19d, 21a, 21b, 29c, 30	114100	Cable Kit, Drum Brake w/Right Hand Tilt, Ht Adj Back Post Short, Back Height 22-25", Inv Axle Plate	1

Item Number	Part Number	Description	Quantity
16-18, 19e, 21a, 21b, 29c, 30	114101	Cable Kit, Drum Brake w/Right Hand Tilt, Ht Adj Back Post Tall, Back Height 20-25", Inv Axle Plate	1
16-18, 19e, 21a, 21b, 29d, 30	114102	Cable Kit, Drum Brake w/Right Hand Tilt, Ht Adj Back Post Tall, Back Height 26-27", Inv Axle Plate	1
16, 17, 19c, 21a, 21b, 29c, 30	114103	Cable Kit, Drum Brake w/Right Hand Tilt, Fixed Height with Adj Handle Back Post Short, Std Axle Plate	1
16, 17, 19d, 21a, 21b, 29d, 30	114104	Cable Kit, Drum Brake w/Right Hand Tilt, Fixed Height with Adj Handle Back Post Tall, Std Axle Plate	1
16, 17, 19d, 21a, 21b, 29c, 30	114105	Cable Kit, Drum Brake w/Right Hand Tilt, Fixed Height with Adj Handle Back Post Short, Inv Axle Plate	1
16, 17, 19e, 21a, 21b, 29d, 30	114106	Cable Kit, Drum Brake w/Right Hand Tilt, Fixed Height with Adj Handle Back Post Tall, Inv Axle Plate	1
4, 12, 16, 17, 19a, 20a, 20b, 22-24, 26a, 29a, 30	114107	Cable Kit, Drum Brake w/Left Hand Tilt, Stroller Handle Back Post Short, Std Axle Plate	1
4, 12, 16, 17, 19b, 20a, 20b, 22-24, 26b, 29b, 30	114108	Cable Kit, Drum Brake w/Left Hand Tilt, Stroller Handle Back Post Tall, Std Axle Plate	1
4, 12, 16, 17, 19b, 20a, 20b, 22-24, 26a, 29a, 30	114109	Cable Kit, Drum Brake w/Left Hand Tilt, Stroller Handle Back Post Short, Inv Axle Plate	1
4, 12, 16, 17, 19c, 20a, 20b, 22-24, 26b, 29b, 30	114110	Cable Kit, Drum Brake w/Left Hand Tilt, Stroller Handle Back Post Tall, Inv Axle Plate	1
4, 12, 16, 17, 19a, 20a, 20b, 22-27, 29a, 30	114111	Cable Kit w/ Folding Hardware, Drum Brake w/Left Hand Tilt, Stroller Handle Back Post Short, Std Axle Plate	1
4, 12, 16, 17, 19b, 20a, 20b, 22-27, 29b, 30	114112	Cable Kit w/ Folding Hardware, Drum Brake w/Left Hand Tilt, Stroller Handle Back Post Tall, Std Axle Plate	1
4, 12, 16, 17, 19b, 20a, 20b, 22-27, 29a, 30	114113	Cable Kit w/ Folding Hardware, Drum Brake w/Left Hand Tilt, Stroller Handle Back Post Short, Inv Axle Plate	1
4, 12, 16, 17, 19c, 20a, 20b, 22-27, 29b, 30	114114	Cable Kit w/ Folding Hardware, Drum Brake w/Left Hand Tilt, Stroller Handle Back Post Tall, Inv Axle Plate	1
4, 16-18, 19c, 21a, 21b, 29b, 30	114115	Cable Kit, Drum Brake w/Left Hand Tilt, Ht Adj Back Post Short, Back Height 18-21", Std Axle Plate	1
4, 16-18, 19c, 21a, 21b, 29c, 30	114116	Cable Kit, Drum Brake w/Left Hand Tilt, Ht Adj Back Post Short, Back Height 22-25", Std Axle Plate	1
4, 16-18, 19d, 21a, 21b, 29c, 30	114117	Cable Kit, Drum Brake w/Left Hand Tilt, Ht Adj Back Post Tall, Back Height 20-25", Std Axle Plate	1

Item Number	Part Number	Description	Quantity
4, 16-18, 19d, 21a, 21b, 29d, 30	114118	Cable Kit, Drum Brake w/Left Hand Tilt, Ht Adj Back Post Tall, Back Height 26-27", Std Axle Plate	1
4, 16-18, 19d, 21a, 21b, 29b, 30	114119	Cable Kit, Drum Brake w/Left Hand Tilt, Ht Adj Back Post Short, Back Height 18-21", Inv Axle Plate	1
4, 16-18, 19d, 21a, 21b, 29c, 30	114120	Cable Kit, Drum Brake w/Left Hand Tilt, Ht Adj Back Post Short, Back Height 22-25", Inv Axle Plate	1
4, 16-18, 19e, 21a, 21b, 29c, 30	114121	Cable Kit, Drum Brake w/Left Hand Tilt, Ht Adj Back Post Tall, Back Height 20-25", Inv Axle Plate	1
4, 16-18, 19e, 21a, 21b, 29d, 30	114122	Cable Kit, Drum Brake w/Left Hand Tilt, Ht Adj Back Post Tall, Back height 26-27", Inv Axle Plate	1
4, 16, 17, 19c, 21a, 21b, 29c, 30	114123	Cable Kit, Drum Brake w/Left Hand Tilt, Fixed Height with Adj Handle Back Post Short, Std Axle Plate	1
4, 16, 17, 19d, 21a, 21b, 29d, 30	114124	Cable Kit, Drum Brake w/Left Hand Tilt, Fixed Height with Adj Handle Back Post Tall, Std Axle Plate	1
4, 16, 17, 19d, 21a, 21b, 29c, 30	114125	Cable Kit, Drum Brake w/Left Hand Tilt, Fixed Height with Adj Handle Back Post Short, Inv Axle Plate	1
4, 16, 17, 19e, 21a, 21b, 29d, 30	114126	Cable Kit, Drum Brake w/Left Hand Tilt, Fixed Height with Adj Handle Back Post Tall, Inv Axle Plate	1
4, 12, 16, 17, 19a, 20b, 22-24, 26a, 29a, 30	114127	Cable Kit, Drum Brake w/Dual Hand Tilt, Stroller Handle Back Post Short, Std Axle Plate	1
4, 12, 16, 17, 19b, 20b, 22-24, 26b, 29b, 30	114128	Cable Kit, Drum Brake w/Dual Hand Tilt, Stroller Handle Back Post Tall, Std Axle Plate	1
4, 12, 16, 17, 19b, 20b, 22-24, 26a, 29a, 30	114129	Cable Kit, Drum Brake w/Dual Hand Tilt, Stroller Handle Back Post Short, Inv Axle Plate	1
4, 12, 16, 17, 19c, 20b, 22-24, 26b, 29b, 30	114130	Cable Kit, Drum Brake w/Dual Hand Tilt, Stroller Handle Back Post Tall, Inv Axle Plate	1
4, 12, 16, 17, 19a, 20b, 22-27, 29a, 30	114131	Cable Kit w/ Folding Hardware, Drum Brake w/Dual Hand Tilt, Stroller Handle Back Post Short, Std Axle Plate	1
4, 12, 16, 17, 19b, 20b, 22-27, 29b, 30	114132	Cable Kit w/ Folding Hardware, Drum Brake w/ Dual Hand Tilt, Stroller Handle Back Post Tall, Std Axle Plate	1
4, 12, 16, 17, 19b, 20b, 22-27, 29a, 30	114133	Cable Kit w/ Folding Hardware, Drum Brake w/Dual Hand Tilt, Stroller Handle Back Post Short, Inv Axle Plate	1
4, 12, 16, 17, 19c, 20b, 22-27, 29b, 30	114134	Cable Kit w/ Folding Hardware, Drum Brake w/DualHand Tilt, Stroller Handle Back Post Tall, Inv Axle Plate	1

Item Number	Part Number	Description	Quantity
4, 16-18, 19c, 21b, 29b, 30	114135	Cable Kit, Drum Brake w/Dual Hand Tilt, Ht Adj Back Post Short, Back Height 18-21", Std Axle Plate	1
4, 16-18, 19c, 21b, 29c, 30	114136	Cable Kit, Drum Brake w/Dual Hand Tilt, Ht Adj Back Post Short, Back Height 22-25", Std Axle Plate	1
4, 16-18, 19d, 21b, 29c, 30	114137	Cable Kit, Drum Brake w/Dual Hand Tilt, Ht Adj Back Post Tall, Back Height 20-25", Std Axle Plate	1
4, 16-18, 19d, 21b, 29d, 30	114138	Cable Kit, Drum Brake w/Dual Hand Tilt, Ht Adj Back Post Tall, Back Height 26-27", Std Axle Plate	1
4, 16-18, 19d, 21b, 29b, 30	114139	Cable Kit, Drum Brake w/Dual Hand Tilt, Ht Adj Back Post Short, Back Height 18-21", Inv Axle Plate	1
4, 16-18, 19d, 21b, 29c, 30	114140	Cable Kit, Drum Brake w/Dual Hand Tilt, Ht Adj Back Post Short, Back Height 22-25", Inv Axle Plate	1
4, 16-18, 19e, 21b, 29c, 30	114141	Cable Kit, Drum Brake w/Dual Hand Tilt, Ht Adj Back Post Tall, Back Height 20-25", Inv Axle Plate	1
4, 16-18, 19e, 21b, 29d, 30	114142	Cable Kit, Drum Brake w/Dual Hand Tilt, Ht Adj Back Post Tall, Back height 26-27", Inv Axle Plate	1
4, 16, 17, 19c, 21b, 29c, 30	114143	Cable Kit, Drum Brake w/Dual Hand Tilt, Fixed Height with Adj Handle Back Post Short, Std Axle Plate	1
4, 16, 17, 19d, 21b, 29d, 30	114144	Cable Kit, Drum Brake w/Dual Hand Tilt, Fixed Height with Adj Handle Back Post Tall, Std Axle Plate	1
4, 16, 17, 19d, 21b, 29c, 30	114145	Cable Kit, Drum Brake w/Dual Hand Tilt, Fixed Height with Adj Handle Back Post Short, Inv Axle Plate	1
4, 16, 17, 19e, 21b, 29d, 30	114146	Cable Kit, Drum Brake w/Dual Hand Tilt, Fixed Height with Adj Handle Back Post Tall, Inv Axle Plate	1
2a, 2b, 3a, 4-7, 9a, 9b, 10, 12, 15, 25, 28a, 32-34	116063	Drum Brake Rotor Kit for 12" Mag Wheels with Hardware PAIR, TILT	1
2a, 2b, 3a, 4-7, 9, 10, 12, 15, 25, 28a	113358	Drum Brake Rotor Kit for 16" Mag Wheels with Hardware PAIR, TILT	1
2a, 2b, 3b, 4-7, 9, 10, 12, 15, 25, 28b	113359	Drum Brake Rotor Kit for MAXX Spoke Wheels with Hardware PAIR, TILT	1
2a, 2b, 3b, 4-7, 9a, 9b, 10, 12, 15, 25, 28a, 32-34	116064	Hardware Kit for Drum Brake Rotor for 12" Mag Wheels PAIR, TILT	1
3a, 4, 5, 6, 9, 10, 12, 15, 25, 28a	113360	Hardware Kit for Drum Brake Rotor for 16" Mag Wheels PAIR, TILT	1
3b, 4, 5, 6, 9, 10, 12, 15, 25, 28b	113361	Hardware Kit for Drum Brake Rotor for MAXX Spoke Wheels, PAIR, TILT	1

Item Number	Part Number	Description	Quantity
2a, 3a, 4-7, 9, 10, 12, 15, 25, 28a	113362	Drum Brake Rotor Kit for Mag Wheels with Hardware, Side A, TILT	1
2b, 3a, 4-7, 9, 10, 12, 15, 25, 28a	113363	Drum Brake Rotor Kit for Mag Wheels with Hardware, Side A, TILT	1
2a, 3b, 4-7, 9, 10, 12, 15, 25, 28b	113364	Drum Brake Rotor Kit for MAXX Spoke Wheels with Hardware, Side B, TILT	1
2b, 3b, 4-7, 9, 10, 12, 15, 25, 28b	113365	Drum Brake Rotor Kit for MAXX Spoke Wheels with Hardware, Side A, TILT	1
3a, 4, 5, 6, 9, 10, 12, 15, 25, 28a	113366	Hardware Kit for Drum Brake Rotor for Mag Wheels, One Side, TILT	2
3b, 4, 5, 6, 9, 10, 12, 15, 25, 28b	113367	Hardware Kit for Drum Brake Rotor for MAXX Spoke Wheels, One Side, TILT	2
1a	111804	12" Mag Wheel with Pneumatic Tire, Drum Brake Hub	2
1b	111805	12" Mag Wheel with Full Poly Tire, Drum Brake Hub	2
1b	111803	16" Mag Wheel with Full Poly Tire, Drum Brake Hub	1
1c, 2-6	002678	Drum Brake Kit, 16" Mag, Pneumatic Tire PAIR	1
1d, 2-6	002680	Drum Brake Kit, 16" Mag, Full Poly Tire PAIR	1
1e, 2-6	002679	Drum Brake Kit, 16" Mag, Pneumatic Tire w/ Airless Insert PAIR	1
2a, 28a	113368	Drum Brake Rotor with Axle Sleeve, Side B, for Mag Wheel	1
2b, 28a	113369	Drum Brake Rotor with Axle Sleeve, Side A, for Mag Wheel	1
2a, 28b	113370	Drum Brake Rotor with Axle Sleeve, Side B, for MAXX Spoke Wheel	1
2b, 28b	113371	Drum Brake Rotor with Axle Sleeve, Side A, for MAXX Spoke Wheel	1
3a	101108	Axle Quick Release w/ Button 1/2" x 99MM <i>Used with 12" and 16" Mag wheels</i>	2
3b	101191	Axle Quick Release w/ Button 1/2" x 110MM <i>Used with 24" MAXX Spoke wheel</i>	2
4	111598	Pinch Bolt	2
7	002465	Adapter, Drum Brake, Focus	2
8a	002463	Axle Plate, Drum Brake R	1
8b	002464	Axle Plate, Drum Brake L	1
9a	101823	M6 X 20 Hhcs Blk Zn	2

Item Number	Part Number	Description	Quantity
9b	102792	M6 x 25, HHCS, Blk Zn <i>Used with 12" Wheels in combination with Inverted Axle Plates</i>	2
10	100746	M6 Flat Washer Blk Zn	4
11	101831	M8 x 80 HHCS Blk Zn	4
12	100658	M6 Nylock Nut Blk Zn	4
13	102386	M6 x 35mm HHCS Blk Zc	2
14	002709	Cover, Wheel Lock Mount <i>Used only with inverted axle plate when no other wheel lock is mounted</i>	2
15	000465	Washer - .725 x 1.5 x .09 F/W ZC PR	2
16	001239	P-Clip 3/16"	2
17	001117	Cable Clip 1" <i>Use quantity 2 per stroller handle back post; quantity 1 per height adjustable back post; quantity 2 per fixed height with adjustable handle back post</i>	4
18	001118	Cable Clip 7/8" <i>Use quantity 1 per height adjustable back post</i>	2
4, 19a	122726	Drum Brake / Hemi Wheel Lock Short Cable <i>Used with short stroller handle back post and standard axle plate</i>	2
4, 19b	122727	Drum Brake / Hemi Wheel Lock Medium Cable <i>Used with with short stroller handle back post and inverted axle plate or tall stroller handle back post and standard axle plate</i>	2
4, 19c	122728	Drum Brake / Hemi Wheel Lock Long Cable <i>Used with tall stroller handle back post and inverted axle plate; short height adjustable back post and standard axle plate; or short fixed height with adjustable handle back post and standard axle plate</i>	2
4, 19d	122729	Drum Brake / Hemi Wheel Lock XL Cable <i>Used with short height adjustable back post and inverted axle plate; tall height adjustable back post and standard axle plate; short fixed height with adjustable handle back post and inverted axle plate; or tall fixed height with adjustable handle back post and standard axle plate</i>	2
4, 19e	122730	Cable, Drum Brake, XXL <i>Used with tall height adjustable back post and standard or inverted axle plate or tall fixed height with adjustable handle and standard or inverted axle plate</i>	2
20a	002673	Brake Lever, Lock, Ang, 25mm <i>Used with stroller handle back posts and left or right hand tilt is present. Not used if dual hand tilt is present.</i>	1

Item Number	Part Number	Description	Quantity
20b, 30	114147	Tilt and Drum Brake Lever, 25MM, with Dual Lever Cable End Adapter <i>Use quantity 1 when stroller handle back posts are present with a left or right hand tilt. Use quantity 2 if dual hand tilt is present.</i>	1
21a	002674	Brake Lever, Lock, Str, 22mm <i>Used with height adjustable and fixed height with adjustable handle back posts and left or right hand tilt is present. Not used if dual hand tilt is present.</i>	1
21b, 30	114148	Tilt and Drum Brake Lever, 22MM, with Dual Lever Cable End Adapter <i>Use quantity 1 when height adjustable and fixed height with adjustable handle back posts are present with left or right hand tilt. Use quantity 2 if dual hand tilt is present.</i>	1
23	100804	Tube End Plug 1"	2
25	100659	M8 Nylock Nut Blk Zn	2
29a	112932	Cable, Tilt w/Drum, Long, Focus <i>Used with short stroller handle back post</i>	1
29b	112933	Cable, Tilt w/Drum, XL <i>Used with tall stroller handle back post or short height adjustable back post with back heights of 18 - 21"</i>	1
29c	112934	Cable, Tilt w/Drum, XXL <i>Used with short height adjustable back post with back heights of 22 - 25" or tall height adjustable back post with back heights of 20 - 25" or short fixed height adjustable handle back post</i>	1
29d	112570	Cable, Tilt w/Drum, XXXL <i>Used with tall height adjustable back post with back heights of 26 - 27" or tall fixed height adjustable handle back post</i>	1
31a	111733	Wheel 24" MAXX Spoke, Drum Brake	2
31b	118358	24" Spoke for Drum Brake, Pneumatic w/ Airless Insert Tire (Black) <i>Replaced kit number 117432. Does not include the handrim. Quote handrim hardware if needed.</i>	2

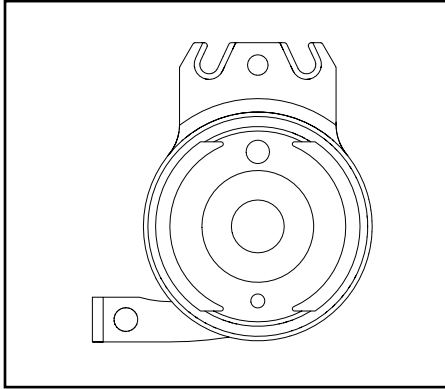

Rotor A - Part No. 111641

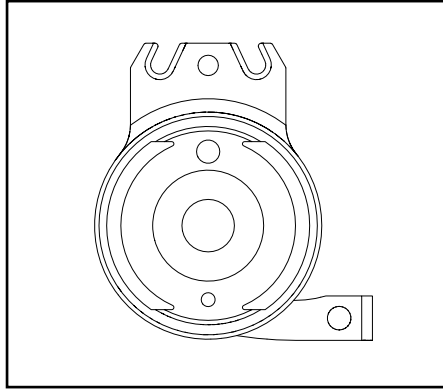

Rotor B - Part No. 111640

Catalyst 5		
Configuration	Left	Right
Axle plate curve up	B	A
Axle plate curve down	A	B

Left: Axle Plate Curve Up
Right: Axle Plate Curve Down

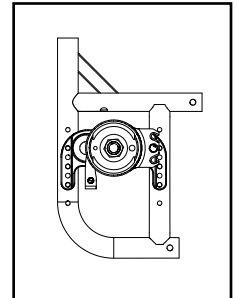
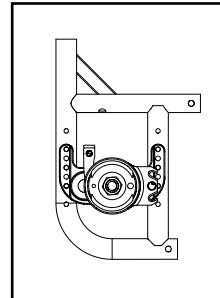

Catalyst 5VX		
Configuration	Left	Right
Axle Position holes 1-5 (top)	A	B
Axle Position holes 6-7 (bottom)	B	A

Left: Axle Position Top
Right: Axle Position Bottom

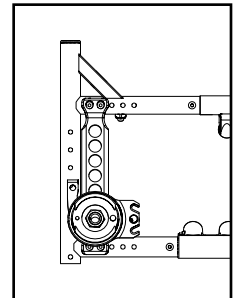
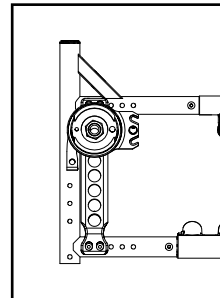

Liberty		
Configuration	Left	Right
All	B	A

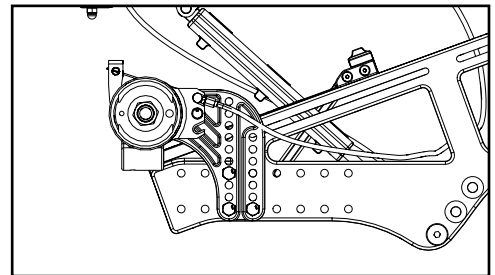

Flip		
Configuration	Left	Right
All	A	B

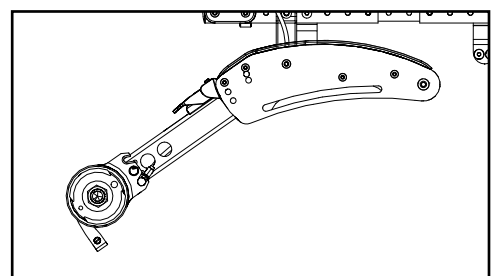

Focus		
Configuration	Left	Right
Standard (mounts above base frame)	A	B
Inverted (mounts below base frame)	B	A

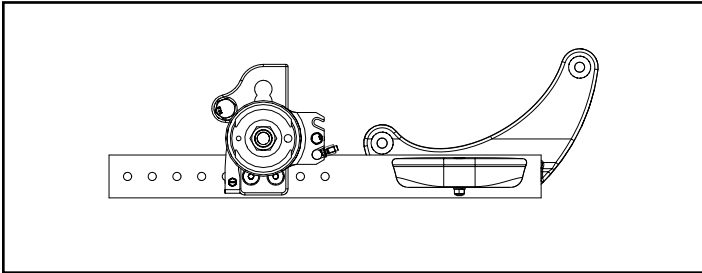

Standard Configuration

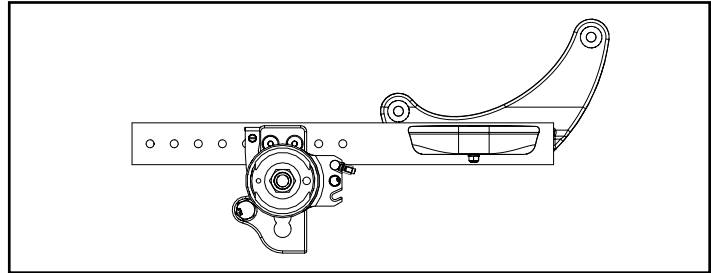

Inverted Configuration

Rigid		
Configuration	Left	Right
Tower 000925 - upper holes (14 or more exposed below clamp)	B	A
Tower 000925 - lower holes (13 or fewer holes exposed below clamp)	A	B
Tower 000926 (all hole locations)	A	B

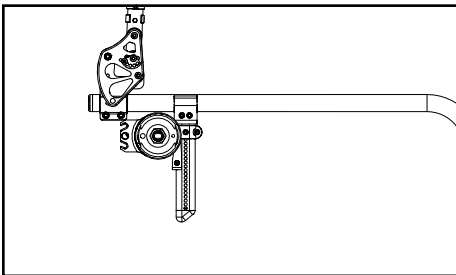

Tower 000925 - Upper Holes

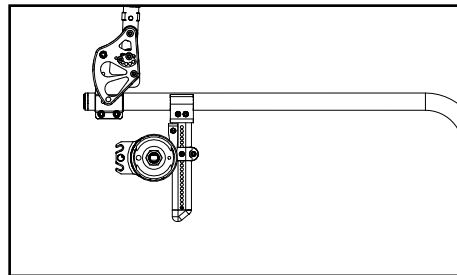

Tower 000925 - Lower Holes

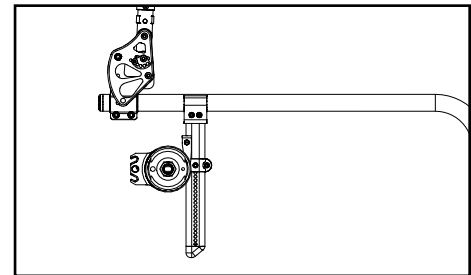

Tower 000926 - All Holes

Arc		
Configuration	Left	Right
All	B	A

